



C A T A L O G O

GIARDINAGGIO

2017



 **papillon**[®]



CATALOGO
GIARDINAGGIO
2017

Macchine da giardino, accessori e articoli di protezione

Pag. 11



Utensili giardinaggio

Pag. 63



Irrigazione, pompe e idropulitori

Pag. 97



Recinzizioni e coperture

Pag. 161



Illuminazione, accessori e tempo libero

Pag. 197



A					
Accendifuoco		pag.			
Accessori per barbecue	227, 228				
Accessori per falci			80		
Accessori per idropultrici	99, 100				
Accessori per innaffio			122		
Accessori per pali rete			196		
Accessori per pompe	108, 109				
Accessori per prodotti a motore			47		
Accumulatori freddo			239		
Acido acetico			225		
Aeratore rompigetto			150		
Affilacatene			44		
Antifuliggine			227		
Aspiratori / soffiatori	24, 25				
Attrezzi a mano acciaio cromato			64		
Attrezzi a mano manico legno/spugna			65		
Attrezzi a mano manico plastica			66		
Attrezzi forgiati			68		
Attrezzi manicati	67÷70				
Attrezzi manicato forgiati			67		
Attrezzini da giardino	64÷66				
Avvolgicavo			12		
Avvolgitubo a carrello	117, 118				
Avvolgitubo a parete	119÷121				
<hr/>					
B		pag.			
Badile			67, 69		
Barbecues a carbonella	229÷231				
Barbecues a gas	232, 233				
Biotrituratore			25		
Borse termiche	238, 239				
<hr/>					
C		pag.			
Cancelli pedonali			187		
Canne in bambù			167		
Cappucci in TNT			172		
Carbone per barbecues			227		
Carrelli	199÷201				
Carrello da giardino			199		
Carrello raccoglitutto			200		
Carriole lamiera			198		
Carriole plastica			198		
Cartucce gas			236		
Cassette box da giardino			96		
Cavo prolunga			12		
Cesoia per potatura			85		
Chiodi a U fissa telo			173		
Ciminiera di accensione			227		
Ciotole alla citronella			216		
Clips per reti			173		
Colla per topi			221		
Coltelli serramanico			95		
Concimi			224		
Cuffie antirumore	50, 51				
<hr/>					
D		pag.			
Decespugliatori	30÷34				
Decespugliatore multifunzione			34		
Derivazioni plastica	148, 149				
Disabituant			223		
Docce per innaffio			135		
Doccia giardino			136		
<hr/>					
E		pag.			
Elettroinsetticidi	217, 218				
Elettropompe autoadescenti	104, 106				
Elettropompe irroratrici			108		
Elettropompe sommergibili	101÷104				
Elettroseghe	40, 41				
Esca antiformiche			221		
Esche rodenticide			222		
<hr/>					
F					pag.
Falci					79, 80
Falciole					77
Faretti					215
Fascette cablaggio					146, 147
Fascette stringitubo					145, 146
Fiaccole citronella					216
Filo in matassine					193, 195
Filo nylon per decespugliatori					37, 38
Filo per legature					192÷195
Filo per reti					191, 192
Filo spinato					191
Filtri					104, 105
Fontane					151, 152
Forbici cogliuva					83
Forbici per erba					84
Forbici per potatura					81÷83
Forbici per siepi					88
Forche					70, 71
Fornelli a gas					234÷236
Fornelli elettrici					234
Fornelloni a gas					235
Frigo Box					238
<hr/>					
G					pag.
Generatori di corrente					45
Griglie cottura					229
Guanti					54÷57
Guanto per barbecue					227
<hr/>					
I					pag.
Idropultrici					98, 99
Innaffiatoi plastica					153
Innesti rapidi	123, 126, 127				
Insetticidi					220÷223
Irrigatori a settori					141÷144
Irrigatori					139÷141
<hr/>					
L					pag.
Lame acciaio per decespugliatori					35
Lame per segoncini					92
Lampade alogene lineari					205
Lampade a gas liquido					237
Lampade solari					215
Lampioni	205÷207, 209, 211				
Lance a pistola					130÷134
Lance in ottone					128
Lanterne	206÷210				
Larvicida					221
Legatrice					194
Lucidante fogliare					223
Lumachicida					222
<hr/>					
M					pag.
Manici a pertica allungabili					76
Manici legno					76
Manici per falci					79, 80
Manometri per autoclavi					109
Mascherine	51÷53				
Mazze					94
Mazze spaccalegna					94
Misuratore di portata					136
Motocoltivatore					22
Motogeneratori					45
Motopompe					107
Motopompe irroratrici					108
Motoseghe	42, 43				
Mototrivella					23
Motozappe					22

N				
Nastro per fascette		pag.		
Nebulizzatori		146		
		154, 158		
O		pag.		
Occhiali		48, 49		
Olio per catene		46		
Olio per lampade		216		
Olio per legno spray		226		
Olio per motore		46		
Olio vaselina		225		
P		pag.		
Paletti a T		190		
Pali recinzione		189, 190		
Palo supporto piante		167		
Pannelli grigliati		188		
Piattina animata		193		
Picconi con manico		94		
Piccozzini		92, 93		
Pietra lavica		227		
Plafoniere		213, 214		
Plafoniere LED		212		
Pompe irroratrici a zaino		155, 156, 158, 159		
Pompe irroratrici per liquidi aggressivi		157, 159		
Pompe a pressione		154÷159		
Portaforbici		80		
Portagomma nylon		109		
Prato sintetico		163		
Prese a doppio rubinetto		124, 128		
Pressostato per autoclavi		109		
Programmatori analogici		137, 138		
Programmatori digitali		138		
Proiettori alogeni		204		
Proiettori LED		202÷204		
R		pag.		
Racchetta elettrica		218		
Raccogli frutta a cestello		84		
Raccordi 5 vie per gruppi pompa		109		
Raccordi di giunzione innaffio		122÷129		
Raccordi nylon per pompe		109		
Raccordi ottone innaffio		127, 128, 147		
Raccordi in polipropilene innaffio		148, 149		
Raccordi rapidi		122, 125÷127		
Rasaerba a motore		14÷16		
Rasaerba elettrici		12, 13		
Rastrelli acciaio		72, 73		
Rastrelli arieggiatori		73		
Rastrelli per erba e fieno		72, 73		
Rastrelliera		75		
Rastrelloni		72, 73		
Repellenti elettrici		219		
Rete antigrandine		169		
Rete antiuccelli		169		
Rete balconi		168		
Rete di sostegno		168		
Rete metallica per recinzione		174÷186		
Rete ombreggiante		165		
Rete per olive		170		
Ricambi per carriole		198, 199		
Roncole		78, 79		
Rubinetti a sfera		150		
Rubinetti per fontane		150		
Ruote per carriole		199		
S		pag.		
Sacco raccogli foglie e erba		162		
Saette		190		
Sarchiatori		71		
Scarpe da lavoro		58÷60		
Scope da giardino		74, 75		
Scope pulizia		74, 75		
Scuotiolive		39		
Scuri con manico		93		
Segacci da potare		89, 90		
Seghezzi		77		
Segoncini ad arco		91, 92		
Sementi		225		
Serre		171		
Set lance per innaffio		128, 129		
Set per barbecue		228		
Siepe sintetica		163, 164		
Sistemi automatici di arresto acqua		106		
Soffietti per zolfo		160		
Solfatrici a spalla		160		
Spaccalegna elettrici		44		
Spazzaneve		23		
Spazzola lavaggio		99, 156		
Stimolante per compostaggio		223		
Stivali		55÷57		
Stoppini per torce bambù		216		
Supporti da parete per tubi irrigazione		121		
Svettatoi a pertica		91		
Svettatoi telescopici		91		
T		pag.		
Tagliabordi a batteria		28		
Tagliabordi elettrici		29, 30		
Tagliarami		86, 87		
Tagliasiepi a motore		28		
Tagliasiepi elettrici		26, 27		
Taniche ferro		47		
Taniche plastica		47, 153		
Tappi auricolari		50		
Teli multiuso		165, 66		
Teli pacciamatura		162		
Teli protezione in TNT		172		
Teloni occhiellati		173		
Tenditori per fili		196		
Terriccio universale		167		
Testine nylon per decespugliatori		36		
Torces bambù citronella		216		
Tralicci estensibili		167		
Trappole per scarafaggi		221		
Trappole per topi e talpe		221		
Trattorini		17÷21		
Treppiedi per irrigatori		142, 144		
Trivelle		23		
Tronchetto antifiliggine		227		
Tubetto PVC per legature		193		
Tubo estensibile per innaffio		110, 121		
Tubo polietilene		149		
Tubo per irrigazione		110÷115		
Tubo poroso		116		
Tubo spiralato		116		
Tute usa e getta		57		
V		pag.		
Valvole a sfera		149		
Valvole di fondo		109		
Valvole di ritegno		109		
Vanghe forgiate		67, 68		
Vasi di espansione per autoclavi		108		
Visiere		50		
Z		pag.		
Zappa scure		94		
Zappe forgiate		67, 68		
Zappette forgiate		68		
Zappette forgiate con manico		67		
Zoccoli PVC		62		

A				
Acetic acid (Vinegar)		pag.	Extension cable	12
Adjustable steel rake		225	Extension cable reel	12
Anti-hail net		74		
Artificial grass		169	F	pag.
Atomizers		163	Face shields	50
Augers		160	Fenced tarps	165
Automatic hose reel		23	Fertilizers	224
Axes		120	Filters	104, 105
		93	Firelighters	226
			Flow meter counter	136
B		pag.	Forged tools	67, 68
Bag for leaves		162	Forks	70, 71
Balconies net		168	Fountains	151, 152
Ball taps		150	Fruit picker	84, 85
Bamboo sticks		167		
Bamboo torches		216	G	pag.
Barbecue glove		227	Garden rope	192÷195
Barbecues		229÷233	Garden shower	136
Barbed wire		191	Garden tools with handle	67÷70
Barrows		198	Garden tools	64÷66
Barrows parts		198, 199	Garden tractors	17÷21
Billhooks		78, 79	Gas barbecues	232, 233
Bird protection net		169	Gas cartridge	236
Boots		61, 62	Gas stoves	234÷236
Bow saws		91, 92	Gas engine lawn mowers	14÷16
Box garden shed		96	Gas hedge trimmer	28
Brass ball valves		149	Gas lamps	237
Brass connectors		127, 128, 147	Gloves	54÷57
Brass nozzles		128	Goggles	48, 49
Brooms		74, 75	Grape shears	83
Brush cutters		30÷34	Grass shears	84
Brush cutter blades		35	Greenhouses	171
			Growing plant support	167
C		pag.	H	pag.
Cable ties		146, 147	Halogen lamps	204, 205
Camping lamps		237	Handtrucks	200, 201
Cast brass taps		150	Hatchets	92, 93
Cast iron gas burners		235	Hedge shears	88
Ceiling		212÷214	Hedge trimmer	26÷28
Chain saw grinder		44	High pressure washers	98÷100
Chain saw lubricant		46	Hoes	67, 68, 70
Chain saws		40÷43	Hose clamps	145, 146
Charcoal bag		227	Hose connectors	122, 125÷127
Chimney starter		227	Hose for irrigation	110÷116
Citronella candles		216	Hose hanger	121
Coated wire		191, 192	Hose nozzles	129÷135
Compost accelerator		223	Hose reel	117÷120
Cooking grills		229		
Cooler bags		238, 239	I	pag.
Cutting heads		36	Ice packs	239
			Impulse sprinklers	141÷144
D		pag.	Insect killer	217, 218
Disposable coveralls		57	Insecticide	220, 221
E		pag.	K	pag.
Ear muffs		50, 51	Knapsack powder blowers	160
Earplugs		50	Knapsack sprayers	155, 156, 158, 159
Earth auger		23	Knives	95
Electric blower		24		
Electric cookers		234	L	pag.
Electric lawn mowers		12, 13	Lamp oil	216
Electric log splitters		44	Lanterns	205÷211
Electric mosquito swatter		218	Lava rock	227
Electric pumps		101÷104, 106	Lawn rakes	72÷74
Extensible hose irrigation		110, 121		
Extensible trellis		167		

Lawn trimmers	28÷30	Set barbecue	228
Lawngroom rakes	73	Shading nets	165
Leaves fencing net	163, 164	Shear holders	80
Led floodlight	202÷204	Shoes	58÷60
Linear halogen lamps	205	Shoulder sprayers	154÷159
Loppers	86, 87	Shower spray nozzles	135
<hr/>		Shredder	25
M	pag.	Sickles	77÷80
Masks	51÷53	Sickles accessories	80
Metal jerry cans	47	Sickles handle	79, 80
Metal networks	174÷186	Slashers	79
Motorgenerators	45	Snow thrower	23
Motor cultivator	22	Spades	67÷70
Motor hoes	23	Spark plugs	47
Motor oil	46	Splitting axes	94
Motorpumps	107, 108	Solar lamps	215
<hr/>		Spiral hose	116
N	pag.	Spotlight	215
Netting support	168	Spray lances	129, 130
Non-woven fabric	172	Sprayers	154÷159
Nozzle set	129, 133	Stationary sprinklers	139
Nylon cutting line	37, 38	Street lamps	205÷207, 209, 211
<hr/>		Submersible pumps	101÷104
O	pag.	Sweeping log	227
Oil for wood	226	<hr/>	
Olive shaker	39	T	pag.
Olives nets	170	Tap aerator	150
Oscillating sprinklers	140, 141	Telescopic handle	76
<hr/>		Telescopic tree pruners	91
P	pag.	Tool rack	75
P.E. Tarpaulins	166	Trash cart	200
Panels	188	Tree pruners	91
Pedestrian gates	187	Tree pruner shears	85
Pest control	220÷222	Trucks	199÷201
Pickaxes	94	Tying machine	194
Plant care	223	<hr/>	
Plastic cans	47, 153	V	pag.
Pole pruner	26	Vacuum blowers	24, 25
Polyethylene black tube	149	Valves	109
Porous hose	116	Vaseline oil	225
Post	189, 190	<hr/>	
Post accessories	196	W	pag.
Potting compost	173	Water timers	137, 139
Pressure sprayers	154, 158	Water distributor	124, 128
Propylene connectors	148, 149	Water nozzles	128÷133
Pruning saws	89, 90	Watering plastic cans	153
Pruning shears	81÷83	Weed barrier mat	162
Pump control	106	Weeders	71
Pumps accessories	108, 109	Wheelbarrows	198
Pumps for aggressive liquids	157, 159	Wire fencing	191, 192
PVC socks	62	Wire pullers	196
<hr/>		Wooden handles	76
Q	pag.	<hr/>	
Quick brass hose connectors	147	<hr/>	
<hr/>		<hr/>	
R	pag.	<hr/>	
Rakes	72÷74	<hr/>	
Repeller electronic	219	<hr/>	
Repeller spray	223	<hr/>	
Riding mowers	19	<hr/>	
Rodent Baits	222	<hr/>	
Rotary sprinklers	139, 140	<hr/>	
<hr/>		<hr/>	
S	pag.	<hr/>	
Saw blades	92	<hr/>	
Seeds	225	<hr/>	

INDICE CODICI / CODES INDEX

50229 – 76	50806 – 116	50907 – 109	51658 – 68	53585 – 62	53923 – 149
50230 – 76	50807 – 116	50908 – 109	51728 – 73	53587 – 62	53925 – 173
50231 – 76	50808 – 116	50909 – 109	51736 – 47	53589 – 62	53943 – 172
50232 – 75	50809 – 116	50910 – 109	51737 – 47	53591 – 62	54174 – 171
50474 – 62	50810 – 116	50911 – 109	51738 – 47	53689 – 173	54175 – 167
50475 – 62	50811 – 116	50912 – 109	51834 – 112	53690 – 173	54220 – 172
50476 – 62	50812 – 116	50913 – 109	51835 – 112	53691 – 173	54309 – 153
50477 – 62	50813 – 112	50915 – 109	51836 – 112	53709 – 46	54335 – 147
50478 – 62	50814 – 112	50916 – 109	51837 – 112	53711 – 46	54404 – 155
50479 – 62	50816 – 112	50917 – 109	51838 – 112	53872 – 106	54453 – 47
50480 – 62	50820 – 143	50918 – 109	51867 – 153	53873 – 147	54600 – 36
50481 – 62	50822 – 143	50919 – 109	52119 – 46	53874 – 147	54621 – 172
50597 – 190	50825 – 143	50923 – 108	52120 – 76	53875 – 147	54626 – 173
50598 – 190	50827 – 144	50924 – 108	52129 – 153	53876 – 147	54627 – 173
50599 – 190	50831 – 144	50943 – 148	52130 – 153	53877 – 147	54687 – 116
50600 – 190	50835 – 144	50944 – 148	52131 – 153	53878 – 147	54691 – 36
50601 – 190	50836 – 144	50945 – 148	52422 – 149	53879 – 147	54692 – 47
50602 – 190	50837 – 144	50946 – 148	52576 – 195	53880 – 147	54693 – 47
50603 – 190	50838 – 144	50947 – 148	52577 – 195	53881 – 147	54958 – 62
50604 – 190	50839 – 144	50948 – 148	52578 – 195	53882 – 147	54959 – 62
50605 – 190	50846 – 108	50950 – 148	52579 – 196	53885 – 149	54966 – 173
50606 – 190	50847 – 108	50951 – 148	52610 – 115	53886 – 149	55037 – 116
50607 – 190	50848 – 106	50952 – 148	52611 – 115	53887 – 149	55038 – 116
50608 – 190	50849 – 106	50953 – 148	52612 – 115	53888 – 148	55099 – 111
50609 – 190	50850 – 106	50954 – 148	52613 – 115	53889 – 148	55100 – 111
50610 – 190	50851 – 106	50959 – 148	52614 – 115	53890 – 148	55101 – 111
50611 – 190	50852 – 106	50960 – 148	52615 – 115	53891 – 148	55102 – 111
50612 – 190	50872 – 108	50961 – 148	52616 – 115	53892 – 148	55103 – 111
50613 – 190	50873 – 109	50962 – 148	52617 – 115	53893 – 148	55104 – 111
50614 – 190	50874 – 109	50963 – 148	52618 – 115	53894 – 148	55105 – 111
50615 – 190	50875 – 109	50964 – 148	52619 – 115	53895 – 148	55106 – 111
50616 – 190	50878 – 109	50965 – 148	52673 – 204	53896 – 148	55413 – 36
50711 – 46	50879 – 109	50974 – 109	52691 – 227	53897 – 148	55451 – 163
50728 – 76	50880 – 109	50975 – 160	53224 – 62	53898 – 148	55453 – 163
50742 – 74	50881 – 109	50976 – 160	53225 – 62	53899 – 148	55491 – 151
50743 – 75	50882 – 109	51102 – 109	53226 – 62	53900 – 148	55492 – 152
50745 – 73	50883 – 109	51103 – 109	53227 – 62	53901 – 148	55493 – 151
50749 – 72	50884 – 109	51104 – 109	53228 – 62	53902 – 148	55494 – 151
50757 – 73	50885 – 109	51105 – 109	53229 – 62	53903 – 148	55495 – 150
50758 – 73	50886 – 109	51106 – 109	53230 – 62	53904 – 148	55496 – 150
50759 – 73	50887 – 109	51107 – 109	53231 – 62	53905 – 148	55497 – 150
50760 – 73	50888 – 109	51108 – 109	53232 – 62	53906 – 148	55519 – 162
50761 – 73	50891 – 109	51109 – 109	53233 – 62	53907 – 148	55520 – 162
50764 – 73	50892 – 109	51110 – 109	53234 – 62	53908 – 148	55522 – 172
50766 – 76	50893 – 109	51111 – 109	53235 – 62	53909 – 148	55524 – 172
50767 – 76	50894 – 109	51112 – 153	53236 – 62	53910 – 148	55618 – 83
50768 – 76	50895 – 109	51113 – 153	53237 – 62	53911 – 148	55619 – 82
50769 – 76	50896 – 109	51114 – 153	53238 – 62	53912 – 149	55620 – 113
50770 – 76	50897 – 109	51115 – 153	53239 – 62	53913 – 149	55622 – 113
50771 – 76	50898 – 109	51116 – 153	53242 – 61	53914 – 149	55623 – 113
50784 – 76	50899 – 109	51246 – 68	53243 – 61	53915 – 149	55624 – 113
50785 – 76	50900 – 109	51516 – 153	53244 – 61	53916 – 149	55625 – 113
50786 – 76	50901 – 109	51517 – 153	53245 – 61	53917 – 149	55626 – 113
50787 – 71	50902 – 109	51518 – 153	53246 – 61	53918 – 149	55627 – 36
50788 – 71	50903 – 109	51519 – 153	53247 – 61	53919 – 149	55673 – 19
50790 – 80	50904 – 109	51520 – 153	53248 – 61	53920 – 149	55674 – 21
50795 – 80	50905 – 109	51611 – 68	53249 – 61	53921 – 149	61130 – 199
50805 – 116	50906 – 109	51644 – 148	53271 – 204	53922 – 149	61131 – 199

INDICE CODICI / CODES INDEX

61132 – 199	80775 – 79	83106 – 64	85995 – 88	87286 – 84	88346 – 127
61335 – 237	80777 – 79	83146 – 37	86087 – 111	87322 – 149	88347 – 127
61336 – 237	80785 – 71	83147 – 37	86167 – 88	87323 – 149	88348 – 127
61343 – 217	80787 – 71	83155 – 167	86386 – 139	87324 – 149	88349 – 127
61344 – 217	80789 – 71	83156 – 167	86387 – 140	87325 – 149	88350 – 127
61345 – 217	80792 – 70	83157 – 167	86389 – 133	87326 – 149	88351 – 128
61346 – 217	80795 – 71	83158 – 167	86391 – 132	87327 – 149	88352 – 127
61359 – 198	80796 – 71	83159 – 167	86392 – 132	87331 – 149	88353 – 127
61436 – 189	80811 – 35	83160 – 167	86413 – 140	87332 – 149	88354 – 128
61437 – 196	80813 – 35	83206 – 37	86572 – 118	87333 – 149	88355 – 128
61438 – 196	80817 – 37	83337 – 146	86618 – 93	87334 – 149	88356 – 128
61439 – 196	80818 – 37	83405 – 87	86619 – 93	87335 – 149	88357 – 128
61440 – 196	80820 – 37	83406 – 87	86622 – 93	87336 – 149	88358 – 132
61459 – 196	80821 – 37	83489 – 47	86810 – 73	87337 – 150	88361 – 89
61460 – 196	80822 – 37	83600 – 196	86906 – 145	87338 – 150	88374 – 130
61527 – 44	80923 – 51	83607 – 235	86907 – 145	87356 – 123	88375 – 130
61528 – 44	81078 – 53	83608 – 235	86908 – 145	87358 – 226	88483 – 146
61537 – 41	81143 – 122	83636 – 70	86909 – 145	87360 – 49	88484 – 146
61550 – 227	81144 – 122	83640 – 64	86910 – 145	87399 – 82	88485 – 146
61597 – 42	81145 – 122	83641 – 64	86911 – 145	87404 – 154	88486 – 146
61598 – 42	81147 – 135	83642 – 64	86912 – 145	87405 – 154	88487 – 146
61599 – 43	81286 – 73	83643 – 64	86913 – 145	87406 – 154	88488 – 146
61600 – 43	81287 – 68	83646 – 64	86914 – 145	87407 – 154	88489 – 146
61601 – 43	81288 – 68	83648 – 133	86915 – 145	87408 – 155	88490 – 146
61602 – 43	81441 – 167	83650 – 141	86916 – 145	87409 – 155	88491 – 146
61605 – 23	81442 – 167	83651 – 141	86917 – 145	87410 – 155	88492 – 146
61606 – 23	81443 – 167	83652 – 140	86918 – 145	87411 – 156	88493 – 146
61617 – 199	81444 – 167	83657 – 91	86919 – 145	87433 – 155	88495 – 146
61650 – 34	81445 – 227	83703 – 69	86920 – 145	87434 – 155	88497 – 146
61651 – 34	81446 – 227	83704 – 72	86921 – 145	87600 – 82	88498 – 146
80094 – 47	81448 – 74	83705 – 72	86922 – 145	87602 – 82	88499 – 146
80095 – 47	81492 – 74	83706 – 72	86923 – 145	87762 – 139	88500 – 146
80187 – 93	81694 – 83	83707 – 72	86924 – 145	87773 – 82	88501 – 146
80189 – 92	81695 – 83	83708 – 70	86925 – 145	87865 – 38	88502 – 146
80195 – 49	81744 – 37	83709 – 70	86934 – 124	87866 – 38	88503 – 146
80196 – 53	81746 – 71	83711 – 69	86936 – 136	87867 – 38	88504 – 146
80210 – 166	81748 – 71	83736 – 35	86939 – 200	87868 – 38	88505 – 146
80211 – 166	82010 – 129	83737 – 35	87128 – 201	87871 – 38	88506 – 146
80212 – 166	82011 – 132	83741 – 141	87200 – 51	87872 – 38	88507 – 146
80213 – 166	82012 – 133	83743 – 124	87201 – 51	87873 – 38	88509 – 146
80214 – 166	82013 – 129	83744 – 124	87202 – 52	88178 – 204	88513 – 57
80215 – 166	82014 – 133	83746 – 139	87203 – 52	88179 – 204	88514 – 57
80361 – 166	82018 – 118	83830 – 111	87204 – 52	88183 – 204	88515 – 57
80381 – 166	82020 – 136	83985 – 49	87205 – 52	88184 – 166	88573 – 51
80692 – 89	82021 – 123	84385 – 121	87230 – 145	88185 – 166	88574 – 51
80693 – 84	82022 – 123	84527 – 89	87231 – 145	88186 – 166	88575 – 52
80696 – 84	82023 – 122	84539 – 201	87232 – 145	88187 – 166	88576 – 52
80697 – 91	82024 – 122	85698 – 89	87233 – 145	88330 – 82	88683 – 62
80698 – 80	82025 – 123	85859 – 37	87234 – 145	88332 – 83	88684 – 62
80701 – 80	82026 – 123	85860 – 37	87235 – 145	88337 – 90	88685 – 62
80702 – 80	82027 – 124	85862 – 37	87236 – 145	88338 – 90	88686 – 62
80703 – 80	82028 – 122	85865 – 64	87237 – 145	88339 – 48	88687 – 62
80759 – 77	82046 – 70	85945 – 166	87238 – 145	88340 – 142	88688 – 62
80760 – 77	82047 – 195	85946 – 166	87239 – 145	88341 – 142	88689 – 62
80765 – 77	82048 – 193	85947 – 89	87240 – 145	88342 – 127	88690 – 62
80766 – 77	82585 – 50	85949 – 47	87241 – 145	88343 – 127	88760 – 201
80767 – 77	82586 – 50	85980 – 139	87278 – 226	88344 – 127	89046 – 48
80770 – 77	82587 – 50	85981 – 139	87285 – 84	88345 – 127	89047 – 48

INDICE CODICI / CODES INDEX

89110 – 140	89905 – 174	91463 – 180	91969 – 162	92551 – 199	92972 – 235
89152 – 51	89906 – 175	91464 – 180	91977 – 169	92555 – 164	92997 – 199
89185 – 121	89907 – 175	91465 – 180	91978 – 169	92556 – 164	93109 – 25
89215 – 195	89908 – 175	91466 – 180	91979 – 169	92579 – 208	93125 – 117
89216 – 195	89909 – 175	91472 – 182	91980 – 169	92589 – 208	93126 – 117
89217 – 195	89910 – 176	91473 – 182	91981 – 169	92599 – 209	93132 – 164
89218 – 195	89911 – 176	91474 – 182	91982 – 169	92600 – 209	93133 – 164
89219 – 195	89912 – 176	91475 – 182	91983 – 169	92601 – 209	93138 – 164
89220 – 195	89913 – 176	91476 – 182	91984 – 169	92602 – 208	93139 – 191
89221 – 195	90147 – 87	91477 – 182	91986 – 173	92603 – 208	93142 – 49
89222 – 195	90148 – 87	91641 – 91	91987 – 173	92604 – 210	93143 – 48
89223 – 195	90149 – 126	91643 – 91	91988 – 173	92605 – 210	93178 – 119
89224 – 195	90150 – 126	91644 – 92	91992 – 168	92606 – 210	93182 – 137
89225 – 195	90151 – 126	91646 – 92	91993 – 168	92607 – 211	93183 – 138
89226 – 195	90152 – 126	91647 – 92	91994 – 168	92608 – 211	93184 – 138
89227 – 195	90153 – 129	91648 – 92	91995 – 168	92609 – 214	93185 – 138
89228 – 195	90155 – 121	91649 – 92	91996 – 169	92610 – 213	93250 – 205
89229 – 195	90156 – 130	91650 – 92	91997 – 169	92611 – 213	93251 – 205
89230 – 195	90157 – 130	91651 – 92	92002 – 168	92612 – 213	93252 – 205
89267 – 174	90837 – 176	91652 – 92	92037 – 146	92613 – 213	93254 – 103
89268 – 174	90838 – 176	91653 – 92	92038 – 146	92614 – 214	93255 – 106
89269 – 174	90979 – 86	91660 – 126	92041 – 58	92615 – 214	93267 – 17
89270 – 174	91018 – 12	91661 – 126	92042 – 58	92616 – 214	93269 – 166
89271 – 174	91113 – 205	91662 – 126	92043 – 58	92617 – 214	93270 – 166
89272 – 174	91142 – 227	91663 – 126	92044 – 58	92618 – 214	93271 – 166
89273 – 174	91189 – 165	91664 – 125	92045 – 58	92619 – 214	93281 – 230
89274 – 174	91190 – 165	91665 – 125	92046 – 58	92620 – 214	93305 – 237
89275 – 174	91191 – 165	91666 – 125	92047 – 58	92621 – 214	93306 – 237
89276 – 174	91192 – 165	91667 – 125	92048 – 58	92622 – 206	93307 – 236
89277 – 174	91193 – 165	91675 – 92	92049 – 58	92625 – 206	93308 – 236
89278 – 174	91194 – 165	91766 – 200	92061 – 183	92655 – 48	93316 – 187
89279 – 174	91264 – 229	91767 – 200	92062 – 183	92689 – 48	93317 – 187
89280 – 174	91324 – 191	91788 – 198	92063 – 183	92751 – 53	93318 – 187
89281 – 175	91325 – 191	91789 – 198	92064 – 183	92752 – 53	93320 – 187
89282 – 175	91341 – 176	91790 – 198	92065 – 183	92769 – 43	93321 – 187
89283 – 175	91440 – 177	91850 – 101	92066 – 179	92831 – 42	93324 – 217
89284 – 175	91441 – 177	91851 – 101	92067 – 179	92832 – 24	93325 – 217
89285 – 176	91442 – 177	91852 – 101	92068 – 179	92878 – 60	93326 – 218
89286 – 176	91443 – 177	91853 – 103	92106 – 185	92879 – 60	93352 – 226
89287 – 176	91444 – 177	91855 – 104	92107 – 185	92880 – 60	93507 – 191
89288 – 176	91445 – 178	91856 – 104	92108 – 185	92881 – 60	93678 – 174
89289 – 176	91446 – 178	91870 – 47	92109 – 185	92882 – 60	93679 – 174
89290 – 176	91447 – 178	91894 – 191	92110 – 185	92883 – 60	93681 – 180
89291 – 176	91448 – 178	91895 – 191	92111 – 185	92884 – 60	93682 – 180
89292 – 176	91449 – 178	91897 – 165	92145 – 125	92885 – 60	93683 – 180
89442 – 82	91450 – 179	91898 – 165	92146 – 125	92912 – 184	93684 – 180
89595 – 88	91451 – 179	91899 – 165	92147 – 126	92913 – 184	93685 – 180
89596 – 86	91452 – 179	91900 – 165	92148 – 126	92914 – 184	93686 – 180
89597 – 86	91453 – 179	91901 – 165	92149 – 129	92915 – 184	93687 – 180
89730 – 52	91454 – 179	91902 – 165	92446 – 28	92916 – 184	93688 – 183
89759 – 175	91455 – 179	91903 – 165	92513 – 127	92917 – 192	93689 – 183
89760 – 175	91456 – 179	91904 – 165	92514 – 127	92918 – 192	93690 – 183
89761 – 175	91457 – 179	91905 – 165	92515 – 127	92919 – 192	93691 – 183
89765 – 157	91458 – 179	91906 – 165	92544 – 156	92920 – 191	93692 – 183
89766 – 157	91459 – 179	91907 – 165	92546 – 125	92923 – 215	93707 – 199
89902 – 174	91460 – 179	91908 – 165	92547 – 122	92924 – 215	93738 – 53
89903 – 174	91461 – 180	91967 – 162	92548 – 122	92925 – 81	93739 – 53
89904 – 174	91462 – 180	91968 – 162	92549 – 123	92926 – 120	93741 – 95

INDICE CODICI / CODES INDEX

93742 – 95	93929 – 198	94591 – 239	95000 – 163	95273 – 192	95624 – 72
93744 – 95	93987 – 117	94594 – 239	95001 – 164	95274 – 191	95625 – 72
93745 – 95	93988 – 117	94595 – 239	95043 – 163	95275 – 191	95626 – 72
93746 – 170	93989 – 117	94596 – 171	95044 – 131	95276 – 191	95627 – 74
93747 – 170	94005 – 50	94597 – 171	95045 – 131	95277 – 219	95628 – 69
93748 – 170	94106 – 204	94598 – 171	95046 – 142	95278 – 219	95629 – 69
93749 – 170	94108 – 170	94599 – 171	95047 – 137	95279 – 219	95630 – 69
93750 – 170	94109 – 170	94600 – 228	95048 – 147	95280 – 219	95631 – 79
93751 – 170	94110 – 170	94601 – 228	95049 – 147	95402 – 163	95632 – 77
93752 – 170	94111 – 170	94605 – 26	95050 – 147	95410 – 122	95633 – 77
93753 – 170	94112 – 170	94606 – 118	95051 – 147	95411 – 122	95634 – 77
93754 – 170	94120 – 43	94607 – 120	95052 – 147	95412 – 125	95635 – 77
93755 – 170	94143 – 226	94607 – 120	95053 – 147	95414 – 226	95636 – 80
93756 – 170	94144 – 172	94627 – 131	95089 – 239	95415 – 226	95637 – 80
93757 – 170	94145 – 172	94628 – 131	95090 – 239	95416 – 229	95638 – 80
93758 – 170	94146 – 172	94632 – 126	95091 – 238	95417 – 230	95639 – 79
93759 – 170	94277 – 94	94633 – 126	95092 – 238	95418 – 231	95642 – 94
93760 – 170	94278 – 94	94634 – 125	95111 – 28	95419 – 230	95643 – 92
93761 – 170	94279 – 94	94635 – 125	95112 – 28	95425 – 228	95644 – 94
93762 – 170	94280 – 93	94687 – 32	95140 – 58	95426 – 228	95645 – 93
93776 – 80	94287 – 171	94688 – 25	95141 – 58	95427 – 228	95647 – 78
93778 – 80	94288 – 171	94698 – 199	95142 – 58	95428 – 228	95648 – 78
93792 – 166	94289 – 171	94704 – 199	95143 – 58	95450 – 50	95649 – 78
93793 – 166	94290 – 171	94716 – 45	95144 – 58	95451 – 50	95650 – 78
93794 – 166	94332 – 236	94717 – 45	95145 – 58	95452 – 44	95651 – 79
93795 – 166	94382 – 55	94718 – 45	95146 – 58	95453 – 44	95653 – 79
93796 – 166	94383 – 55	94719 – 45	95147 – 58	95465 – 158	95654 – 78
93832 – 206	94384 – 55	94737 – 102	95148 – 58	95466 – 158	95671 – 105
93833 – 215	94388 – 54	94738 – 104	95160 – 59	95479 – 141	95672 – 105
93834 – 215	94389 – 54	94740 – 42	95161 – 59	95480 – 75	95673 – 105
93835 – 215	94390 – 54	94745 – 166	95162 – 59	95483 – 16	95674 – 105
93865 – 12	94394 – 23	94754 – 216	95163 – 59	95499 – 207	95675 – 105
93866 – 188	94427 – 227	94758 – 181	95164 – 59	95500 – 207	95676 – 105
93867 – 188	94450 – 164	94759 – 181	95165 – 59	95501 – 207	95677 – 105
93868 – 188	94451 – 41	94760 – 181	95166 – 59	95502 – 207	95678 – 105
93869 – 188	94452 – 163	94761 – 181	95167 – 59	95534 – 96	95679 – 105
93870 – 189	94453 – 163	94762 – 181	95168 – 59	95535 – 96	95680 – 105
93871 – 189	94507 – 44	94763 – 181	95176 – 239	95537 – 168	95681 – 104
93872 – 189	94522 – 26	94764 – 181	95178 – 239	95538 – 169	95682 – 105
93873 – 189	94524 – 27	94765 – 181	95184 – 158	95539 – 169	95683 – 105
93874 – 189	94526 – 18	94766 – 181	95185 – 158	95600 – 67	95694 – 224
93875 – 189	94531 – 35	94767 – 181	95186 – 158	95601 – 67	95695 – 224
93876 – 189	94547 – 218	94768 – 181	95188 – 159	95604 – 68	95696 – 224
93877 – 189	94548 – 218	94769 – 181	95202 – 216	95605 – 67	95697 – 224
93878 – 189	94549 – 217	94770 – 181	95203 – 216	95606 – 67	95698 – 224
93879 – 189	94550 – 217	94771 – 181	95204 – 216	95607 – 67	95699 – 224
93880 – 189	94551 – 186	94772 – 95	95205 – 216	95608 – 69	95700 – 224
93881 – 189	94552 – 186	94790 – 22	95261 – 234	95611 – 67	95701 – 224
93882 – 189	94553 – 186	94856 – 146	95262 – 234	95612 – 67	95702 – 224
93885 – 83	94554 – 186	94857 – 146	95263 – 213	95614 – 67	95703 – 224
93886 – 81	94555 – 186	94965 – 89	95264 – 213	95615 – 67	95704 – 223
93887 – 81	94579 – 216	94966 – 90	95266 – 191	95616 – 67	95706 – 223
93892 – 188	94580 – 216	94967 – 90	95267 – 191	95617 – 67	95724 – 193
93895 – 14	94581 – 216	94969 – 146	95268 – 191	95618 – 70	96235 – 39
93898 – 22	94582 – 216	94970 – 146	95269 – 191	95619 – 70	96482 – 226
93900 – 236	94583 – 216	94973 – 23	95270 – 192	95620 – 70	96540 – 202
93905 – 136	94585 – 216	94974 – 107	95271 – 192	95621 – 70	96541 – 203
93906 – 85	94586 – 216	94999 – 163	95272 – 191	95623 – 71	96581 – 98

INDICE CODICI / CODES INDEX

96582 – 98	97146 – 192	97944 – 221	98888 – 56	99188 – 223
96583 – 99	97147 – 192	97945 – 223	98889 – 55	99189 – 220
96584 – 99	97148 – 192	97946 – 223	98890 – 55	99190 – 236
96585 – 99	97149 – 192	97947 – 222	98891 – 55	99191 – 234
96586 – 99	97445 – 62	98021 – 150	98892 – 54	99192 – 234
96587 – 100	97446 – 62	98022 – 150	98893 – 54	99193 – 235
96588 – 100	97447 – 61	98200 – 74	98894 – 54	99194 – 220
96589 – 100	97675 – 146	98201 – 74	98895 – 54	99195 – 232
96590 – 100	97676 – 146	98202 – 65	98896 – 54	99196 – 232
96591 – 100	97679 – 62	98203 – 65	98897 – 54	99213 – 238
96592 – 99	97680 – 62	98206 – 65	98898 – 54	99214 – 238
96593 – 100	97681 – 62	98207 – 65	98899 – 54	99215 – 238
96594 – 100	97682 – 62	98208 – 65	98900 – 54	99216 – 168
96716 – 105	97683 – 56	98210 – 60	98901 – 54	99217 – 168
96717 – 105	97684 – 56	98211 – 60	98902 – 56	99218 – 168
96719 – 29	97685 – 56	98212 – 60	98903 – 56	99219 – 46
96720 – 30	97720 – 233	98213 – 60	98904 – 56	99220 – 225
96721 – 24	97731 – 227	98214 – 60	98955 – 212	99221 – 46
96722 – 29	97739 – 159	98215 – 60	98959 – 219	99222 – 46
96723 – 29	97740 – 159	98216 – 60	98960 – 219	99271 – 226
96724 – 30	97743 – 62	98217 – 60	98982 – 203	99326 – 194
96725 – 29	97744 – 62	98218 – 60	98983 – 204	99327 – 194
96726 – 29	97755 – 85	98236 – 82	98984 – 203	99328 – 194
96727 – 30	97756 – 202	98310 – 212	98998 – 66	99329 – 194
96785 – 205	97757 – 202	98311 – 212	98999 – 66	99330 – 194
96786 – 205	97758 – 202	98312 – 212	99000 – 66	99331 – 194
96798 – 81	97759 – 203	98313 – 212	99001 – 66	99335 – 193
96844 – 119	97761 – 205	98408 – 198	99002 – 66	99336 – 193
96845 – 121	97774 – 110	98423 – 236	99003 – 66	99337 – 193
96847 – 20	97775 – 110	98473 – 61	99004 – 66	99338 – 193
96848 – 33	97776 – 110	98474 – 61	99007 – 235	99339 – 193
96849 – 12	97777 – 110	98475 – 61	99008 – 32	99340 – 193
96851 – 146	97832 – 162	98476 – 61	99009 – 29	99341 – 193
96852 – 146	97833 – 162	98477 – 61	99010 – 27	99342 – 193
96853 – 146	97834 – 162	98478 – 61	99011 – 40	99343 – 193
96854 – 146	97835 – 162	98479 – 61	99012 – 40	99344 – 193
96855 – 146	97843 – 30	98480 – 61	99013 – 40	99347 – 49
96856 – 146	97844 – 31	98694 – 145	99029 – 40	99352 – 194
96857 – 146	97845 – 34	98695 – 145	99041 – 152	99373 – 202
96858 – 146	97846 – 31	98696 – 145	99042 – 150	99374 – 202
96894 – 225	97847 – 33	98697 – 145	99067 – 107	99377 – 202
96895 – 225	97849 – 14	98708 – 57	99069 – 22	99378 – 202
96896 – 224	97850 – 15	98709 – 57	99091 – 102	
96943 – 48	97851 – 16	98710 – 57	99092 – 37	
96944 – 48	97859 – 135	98749 – 145	99093 – 38	
97123 – 218	97860 – 137	98750 – 145	99094 – 38	
97130 – 59	97861 – 137	98769 – 85	99095 – 38	
97131 – 59	97933 – 222	98877 – 55	99096 – 38	
97132 – 59	97934 – 222	98878 – 55	99097 – 229	
97133 – 59	97935 – 222	98879 – 55	99098 – 229	
97134 – 59	97936 – 221	98880 – 55	99099 – 229	
97135 – 59	97937 – 221	98881 – 55	99100 – 229	
97136 – 59	97938 – 221	98882 – 55	99101 – 229	
97137 – 59	97939 – 220	98883 – 56	99102 – 229	
97138 – 59	97940 – 220	98884 – 56	99176 – 13	
97142 – 173	97941 – 221	98885 – 56	99182 – 134	
97144 – 167	97942 – 221	98886 – 56	99185 – 15	
97145 – 192	97943 – 221	98887 – 56	99187 – 225	



**MACCHINE DA GIARDINO, ACCESSORI
E ARTICOLI DI PROTEZIONE**



**CATALOGO
GIARDINAGGIO
2017**



rasaerba elettrici electric lawn mowers



mod. G 134-EL

Per prati fino a 500 m²	Cutting surface up to 500 m ²
Motore 1000 watt - 230 V	Motor 1000 watt - 230V
Telaio in polipropilene	Polypropylene deck
Taglio regolabile a 3 posizioni	3-step height adjustment
Altezza di taglio 25 - 40 - 55 mm	Cutting height 25 - 40 - 55 mm
Larghezza scocca/taglio cm 34/32	Carter/cutting width 34/32 cm
Ruote Ø 127/127 mm	Wheels Ø 127/127 mm
Cesto raccoglierba 35 lt	Grass box 35 lt
Peso 10 Kg	Weight 10 Kg

• 96849



**1000
watt**



prolunga e avvolgicavo extension cable and cable reel



MAURER

Cavo prolunga per giardino

Cavo 25 metri
Sez. 2x1,5 mm²
Spina-presa 2P 16A Schuko

Garden extension cable
Cable 25 m
Sez. 2x1,5 mm²
Plug-socket 2P 16A Schuko

• 91018



MAURER

Avvolgicavo mod. Giardino

Cavo 25 metri
Sez. 3x1,5 mm²
Spina-presa 2P 16A Schuko
Costruito a norme

Cable reel garden model
Cable 25 m
Sez. 3x1,5 mm²
Plug-socket 2P 16A Schuko
Electrical standards

• 93865





mod. G 138-EL

Per prati fino a 600 m²

Cutting surface up to 600 m²

Motore 1500 watt - 230 V
 Telaio in polipropilene
 Taglio regolabile a 3 posizioni
 Altezza di taglio 25 - 40 - 60 mm
 Larghezza scocca/taglio cm 38/36
 Ruote Ø 127/140 mm
 Cesto raccogliherba 50 lt
 Peso 10,7 Kg

Motor 1500 watt - 230 V
 Polypropylene deck
 3-step height adjustment
 Cutting height 25 - 40 - 60 mm
 Carter/cutting width 38/36 cm
 Wheels Ø 127/140 mm
 Grass box 50 lt
 Weight 10,7 Kg

• 99176



**1500
watt**





rasaerba motore a scoppio gas engine lawn mowers



mod. GREEN 40

Per prati fino a 800 m² Cutting surface up to 800 m²

Motore OHV 4T - 135 cc - valvole in testa	Engine OHV 4T - 135 cc - overhead valves
Telaio lamiera acciaio verniciato	Painted steel deck
10 posizioni di taglio (20~70 mm) a regolazione centralizzata	10-steps central cut height adjustment (20~70 mm)
Larghezza scocca/taglio cm 40/38	Carter/cutting width 40/38 cm
Ruote Ø 180/205 mm	Wheels Ø 180/205 mm
Freno motore di sicurezza	Automatic brake
Cesto raccogliherba 50 lt	Grass box 50 lt
Deflettore parasassi	Stones guard
Peso 30 Kg	Weight 30 Kg

• 93895



mod. GREEN 48/NK

Per prati fino a 1000 m² Cutting surface up to 1000 m²

Motore WB 45 OHV 4T - 139 cc - valvole in testa	Engine WB 45 OHV 4T - 139 cc - overhead valves
Telaio lamiera acciaio verniciato	Painted steel deck
5 posizioni di taglio (27~80 mm) a regolazione centralizzata	5-steps central cut height adjustment (27~80 mm)
Taglio con sistema mulching	Mulching system
Larghezza scocca/taglio cm 48/46	Carter/cutting width 48/46 cm
Ruote Ø 180/240 mm - con cuscinetti	Wheels Ø 180/240 mm - w/ ball bearings
Freno motore di sicurezza	Automatic brake
Cesto raccogliherba 60 lt	Grass box 60 lt
Deflettore parasassi	Stones guard
Peso 31 Kg	Weight 31 Kg

97849





mod. GREEN 48-SP/NK

Per prati fino a 1400 m²	Cutting surface up to 1400 m ²
Motore OHV 4T - 135 cc - valvole in testa	Engine OHV 4T - 135 cc - overhead valves
Semoenza posteriore con disinnesto automatico	Self-propelled with rear traction
Telaio lamiera acciaio verniciato	Painted steel deck
8 posizioni di taglio (25~70 mm) a regolazione centralizzata	8-steps central cut height adjustment (25~70 mm)
Taglio con sistema mulching	Mulching system
Larghezza scocca/taglio cm 48/46	Carter/cutting width 48/46 cm
Ruote Ø 180/280 mm - con cuscinetti	Wheels Ø 180/280 mm - w/ ball bearings
Freno motore di sicurezza	Automatic brake
Cesto raccogliherba 60 lt	Grass catcher bag 60 lt
Peso 36 Kg	Weight 36 Kg

• 99185



mod. GREEN 48-SP/NK B&S

Per prati fino a 1500 m²	Cutting surface up to 1500 m ²
Motore Briggs & Stratton 500 E SERIES - 140 cc	Briggs & Stratton engine 500 E SERIES - 140 cc
Semoenza posteriore con disinnesto automatico	Self-propelled with rear traction
Telaio lamiera acciaio verniciato	Painted steel deck
5 posizioni di taglio (27~80 mm) a regolazione centralizzata	5-steps central cut height adjustment (27~80 mm)
Taglio con sistema mulching	Mulching system
Larghezza scocca/taglio cm 48/46	Carter/cutting width 48/46 cm
Ruote Ø 180/240 mm - con cuscinetti	Wheels Ø 180/240 mm - w/ ball bearings
Freno motore di sicurezza	Automatic brake
Cesto raccogliherba 60 lt	Grass catcher bag 60 lt
Peso 34 Kg	Weight 34 Kg

97850



Powered by





rasaerba motore a scoppio gas engine lawn mowers



mod. GREEN 53-SP/N

Per prati fino a 2100 m²

Cutting surface up to 2100 m²

Motore OHV 4T - 173 cc - valvole in testa
Semovenza posteriore con disinnesto automatico
Telaio lamiera acciaio verniciato
6 posizioni di taglio (25~75 mm) a regolazione centralizzata
Taglio con sistema mulching
Larghezza scocca/taglio cm 53/51
Ruote Ø 180/255 mm - con cuscinetti
Freno motore di sicurezza
Cesto raccogliherba 60 lt
Peso 40,5 Kg

Engine OHV 4T - 173 cc - overhead valves
Self-propelled with rear traction
Painted steel deck
6-steps central cut height adjustment (25~75 mm)
Mulching system
Carter/cutting width 53/51 cm
Wheels Ø 180/255 mm - w/ ball bearings
Automatic brake
Grass catcher bag 60 lt
Weight 40,5 Kg

• 95483



8 000071 954839



4 in 1



mod. GREEN 53/N - 4 in 1

Per prati fino a 2800 m²

Cutting surface up to 2800 m²

Motore Briggs & Stratton 675 EXi - 4T - 163 cc
Semovenza posteriore con disinnesto automatico
Telaio lamiera acciaio verniciato
Taglio 4 in 1 (taglio, raccolta, scarico laterale, sistema mulching)
6 posizioni di taglio (27÷90 mm) a regolazione centralizzata
Larghezza scocca/taglio cm 53/51
Ruote Ø 200/280 mm - con cuscinetti
Freno motore di sicurezza
Cesto raccogliherba 55 lt
Peso 38 Kg

Engine Briggs & Stratton 675 EXi - 4T - 163 cc
Self-propelled with rear traction
Painted steel deck
4 in 1 (Rear discharge, collecting, side discharge, mulching)
6-steps central cut height adjustment (27÷90 mm)
Carter/cutting width 53/51 cm
Wheels Ø 200/280 mm - w/ ball bearings
Automatic brake
Grass catcher bag 55 lt
Weight 38 Kg

97851



8 000071 978514



Powered by



**mod. GT 98**

Per prati fino a 4000 m²
 Motore GGP serie 7500 - 432 cc OHV - 4T - valvole in testa
 Trasmissione meccanica
 Cambio 5 marce avanti + retromarcia
 Avviamento elettrico
 Telaio acciaio+ABS
 Taglio bilama 98 cm
 Altezza di taglio regolabile in 7 posizioni
 da 25 a 80 mm
 Sistema di taglio mulching (completo di kit mulching)
 Scarico laterale
 Ruote Ø 15" x 18"
 Ruote su cuscinetti
 Dispositivo sicurezza freno motore
 Sedile regolabile
 Microinterruttori di sicurezza: sedile, lame, cambio, freno
 parcheggio
 Caricabatterie incluso
 Peso 215 Kg

Cutting surface up to 4000 m²
 Engine GGP series 7500 - 432 cc OHV - 4T - overhead valves
 Mechanical drive
 5 speed + RM
 Electric starter
 Steel+ABS deck
 Cutting 98 cm with double blades
 7 step quick height adjustment from
 25 to 80 mm
 Mulching cutting system (kit mulching included)
 Lateral discharge
 Wheels Ø 15" x 18"
 Ball bearing wheels
 Quick-stall safety switch
 Adjustable seat
 Safety micro-switches: seat, blades, transmission, stopping
 break
 Battery charger included
 Weight 215 Kg

93267

8 000071 932677





trattorini garden tractors



mod. GT 84

Per prati fino a 4000 m²
 Motore GGP serie 7500 - 432 cc OHV - 4T - valvole in testa
 Trasmissione meccanica
 Cambio 5 marce avanti + retromarcia
 Avviamento elettrico
 Telaio acciaio+ABS
 Taglio bilama 84 cm
 Altezza di taglio regolabile in 7 posizioni
 da 25 a 80 mm
 Sistema di taglio mulching (completo di kit mulching)
 Scarico posteriore
 Volume sacco raccolta 240 litri
 Ruote Ø 15"x18"
 Ruote su cuscinetti
 Caricabatterie incluso
 Peso 192,30 Kg

Cutting surface up to 4000 m²
 Engine GGP series 7500 - 432 cc OHV - 4T - overhead valves
 Mechanical drive
 5 speed + RM
 Electric starter
 Steel+ABS deck
 Cutting 84 cm with double blades
 7 step quick height adjustment from
 25 to 80 mm
 Mulching cutting system (kit mulching included)
 Rear discharge
 Grass catcher 240 litres
 Wheels Ø 15"x18"
 Ball bearing wheels
 Battery charger included
 Weight 192,30 Kg

94526



8 000071 945264



**mod. XE 866 B**

Per prati fino a 3000 m ²	Cutting surface up to 3000 m ²
Motore Briggs & Stratton SERIE 875	Engine Briggs & Stratton 875 SERIES
Cambio 4 marce avanti + retromarcia	4 speed + RM
Avviamento elettrico	Electric starter
Ampiezza taglio 66 cm	Wide cut 66 cm
Scarico posteriore	Rear bagger
Volume sacco raccolta 150 lt	Grass catcher 150 lt
Trasmissione meccanica	Mechanical drive
Ruote Ø 13"x15"	Wheels Ø 13"x15"
Cruscotto 1 LED	1 LED instrument board
Innesto lama manuale	Handle blade clutch
Serbatoio 3,8 lt	Tank 3,8 lt
Caricabatterie incluso	Battery charger included
Peso 154 Kg	Weight 154 Kg

55673

8 008984 613119



Powered by





trattorini garden tractors



Powered by



mod. PGX 140 HD

Per prati fino a 4000 m²
 Motore Briggs & Stratton 3130 AVS - 344 cc
 Ampiezza taglio 92 cm
 Cambio 5 marce avanti + retromarcia
 Avviamento elettrico
 Scarico posteriore
 Volume sacco raccolta 260 lt
 Trasmissione idrostatica
 Ruote Ø 15"x18"
 Cruscotto 1 LED
 Innesto lama elettromagnetico
 Serbatoio 4,5 lt
 Caricabatterie non incluso
 Peso 220 Kg

Cutting surface up to 4000 m²
 Engine Briggs & Stratton 3130 AVS - 344 cc
 Wide cut 92 cm
 5 speed + RM
 Electric starter
 Rear bagger
 Grass box 260 lt
 Hydraulic transmission
 Wheels Ø 15"x18"
 1 LED instrument board
 Electromagnetic blade clutch
 Tank 4,5 lt
 Battery charger not included
 Peso 220 Kg

96847





mod. PTX 170 HD

Per prati fino a 6000 m²
 Motore B&S 4165 AVS - 500 cc
 Ampiezza taglio 102 cm
 Avviamento elettrico
 Scarico posteriore
 Volume sacco raccolta 260 lt
 Trasmissione idrostatica
 Ruote Ø 15"x18"
 Cruscotto 1 LED
 Innesto lama elettromagnetico
 Serbatoio 6,0 lt
 Caricabatterie incluso
 Peso 222 Kg

Cutting surface up to 6000 m²
 Engine B&S 4165 AVS - 500 cc
 Wide cut 102 cm
 Electric starter
 Rear bagger
 Grass box 260 lt
 Hydraulic transmission
 Wheels Ø 15"x18"
 1 LED instrument board
 Electromagnetic blade clutch
 Tank 6,0 lt
 Battery charger included
 Weight 222 Kg

55674



Powered by





motozappe / motocoltivatore motor hoes / motor cultivator



mod. GREEN ZAP

Motore 4T - 140cc

Engine 4T - 140cc

Cambio monomarcia
Trasmissione a vite senza fine e cinghia
Larghezza di aratura 40 cm
Capacità serbatoio 0,9 lt
Carter di protezione
Stegole di guida registrabili
Ruotino di trasferimento
Peso 32,5 Kg

Gearbox 1 speed
Transmission by worm gearing and belt
Cutting width 40 cm
Fuel tank capacity 0,9 lt
Trees guard discs
Adjustable handler-bar
Transport tire
Weight 32,5 Kg

• 93898



CE



mod. GREEN ZAP 60

Motore 4T - 173cc

Engine 4T - 173cc

Cambio monomarcia
Trasmissione a vite senza fine e cinghia
Larghezza di aratura 60 cm
Capacità serbatoio 0,9 lt
Carter di protezione
Stegole di guida registrabili
Ruotino di trasferimento
Peso 35 Kg

Gearbox 1 speed
Transmission by worm gearing and belt
Cutting width 60 cm
Fuel tank capacity 0,9 lt
Trees guard discs
Adjustable handler-bar
Transport tire
Weight 35 Kg

• 94790



CE



mod. WGT 60

Motore OHV 4T - 212 cc

Engine OHV 4T - 212 cc

Cambio a 2 marce (avanti - retromarcia)
Trasmissione cinghia + ingranaggio
Accensione a strappo
Larghezza di aratura 60 cm
12 lame
Profondità di aratura 175~350 mm
Capacità serbatoio 3,6 lt
Carter di protezione
Peso netto 68 Kg

2 gears (forward - reverse)
Transmission by worm gearing and belt
Pull starter
Cutting width 60 cm
12 blades
Cultivated Depth 175~350 mm
Fuel tank capacity 3,6 lt
Rotor Cover
Net weight 68 Kg

• 99069



CE



mod. EA 43

Motore 2T - Euro2 - 42,7 cc

Engine 2T - Euro2 - 42,7 cc

Motore 2 tempi con raffreddamento ad aria
 Capacità serbatoio 1 lt
 Miscela 2% (50:1)
 Rapporto di riduzione 40:1
 Velocità trivella 200-230 giri/min
 Impugnatura a due mani
 Peso 9,5 Kg
 (trivella non inclusa)

2 stroke gasoline engine with air-cooled
 Fuel tank capacity 1 lt
 Mixture 2% (50:1)
 Gear reduction ratio 40:1
 Auger speed 200-230 r.p.m.
 Handlebar (one-person)
 Weight 9,5 Kg
 (auger bit not included)

• 94973



Trivella / Auger bit

• 61605

ø 10 cm - lungh. 73 cm



• 61606

ø 15 cm - lungh. 73 cm



mod. WHITE 35

Motore OHV - 4T - 196 cc - valvole in testa

Engine OHV - 4T - 196 cc - overhead valves

Capacità serbatoio 3,5 lt
 Larghezza di lavoro 550 mm
 Altezza di lavoro 510 mm
 Diametro coclea 300 mm
 Max. velocità rotazione coclea 1350 giri/min
 Ruote 13"
 Peso netto 76 Kg

Fuel tank capacity 3,5 lt
 Working width 550 mm
 Working height 510 mm
 Auger diameter 300 mm
 Max rotation speed of auger 1350 giri/min
 Wheels 13"
 Net weight 76 Kg

• 94394





aspiratore soffiatore elettrico electric vacuum blower



mod. ASSO 250

Potenza 2500 watt

Power 2500 watt

Velocità variabile

Variable speed

Velocità aria: 270 km/ora

Air speed: 270 km/h

Volume aria spostata: 0,13 m³/s

Blow volume: 0,13 m³/s

Sacco raccogliore: 40 lt (volume)

Bag capacity: 40 lt

Dispositivo triturazione interna (Mulching)
rapporto 10:1

Mulching up to 10:1 ratio

Leva di selezione per il cambio rapido da
aspiratore a soffiatore

Converting from vacuum to blower by large
control lever

Compatto e leggero

Compact and light balance

Peso 4,5 Kg

Weight 4,5 Kg

• 92832



A velocità variabile per regolare la potenza.
A variable speed to adjust the power.

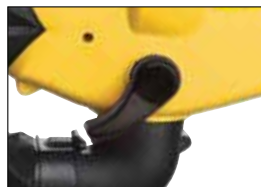

Impugnatura regolabile. Conversione rapida da aspiratore a soffiatore, con leva.
Adjustable handle. Converting from vacuum to blower by large control lever



mod. ASSO 260

Potenza 2600 watt

Power 2600 watt

Velocità aria: 270 km/ora

Air speed: 270 km/h

Volume aria spostata: 0,13 m³/s

Blow volume: 0,13 m³/s

Sacco raccogliore: 45 lt (volume)

Bag capacity: 45 lt

Dispositivo triturazione interna (Mulching)
rapporto 10:1

Mulching up to 10:1 ratio

Leva di selezione per il cambio rapido da
aspiratore a soffiatore

Converting from vacuum to blower by large
control lever

Compatto e leggero

Compact and light balance

Peso 4,5 Kg

Weight 4,5 Kg

• 96721





mod. VB 26E

Motore 2T - EURO 2 - 26cc

Engine 2T - EURO 2 - 26cc

Velocità aria 250 km/h

Air speed 250 km/h

Volume aria spostata 11 m³/min

Blow volume 11 m³/min

Sistema triturazione interna (Mulching)
rapporto 10:1

Mulching system to 10:1 ratio

Sacco raccogliore 35 litri

Bag capacity 35 lt

Miscela 40:1

Fuel mixture 40:1

Peso 5,7 Kg

Weight: 5,7 Kg

• 94688



EURO 2



mod. BTR 2400

Potenza 2400 watt - 4500 giri/min

Power 2400 watt - 4500 rpm

Diametro max di taglio 40 mm

Max cutting diameter 40 mm

Sistema di taglio con 2 lame rotanti

Two rotating blades cutting system

Interruttore di sicurezza in caso di
apertura vano lame

Safety cut-off switch

Freno motore

Motor brake

Protezione da sovraccarico

Overload protection

Alimentatore con maniglia incluso

Plunger with handle included

• 93109

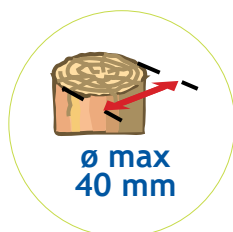



tagliasiepi potatore elettrico electric hedge trimmer - pole pruner

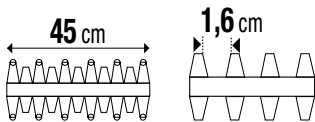

mod. TES

Potenza 710 W / 450 W

Power 710 W / 450 W

Con asta telescopica
 Funzione POTATORE: Potenza 710 watt
 Lunghezza barra potatore 20 cm
 Lunghezza 192÷265 cm
 Funzione TAGLIASIEPI: Potenza 450 watt
 Lunghezza lama tagliasiepi 45 cm
 Diametro di taglio 16 mm
 Lunghezza 205÷279 cm
 Testa tagliasiepi orientabile a 135°

With telescopic handle
 POLE PRUNER: power 710 watt
 Bar length 20 cm
 Shaft length 192÷265 cm
 TRIMMER: power 450 watt
 Blade length 45 cm
 Cutting diameter 16 mm
 Shaft length 205÷279 cm
 Hedge trimmer with 135° head rotation

• 94605



tagliasiepi elettrico electric hedge trimmers



mod. TSP 51/16 N

Potenza 500 W - 230 V

Power 500 W -230 V

Lame a movimento contrapposto rinforzate
 Lunghezza taglio cm 51
 Diametro di taglio mm 16
 Freno elettrico
 Arresto immediato delle lame
 Interruttore di sicurezza a due mani
 Peso 2,2 Kg

Double action blades, hardened
 Cutting length cm 51
 Cutting diameter 16 mm
 Electric brake
 Blades-brake device
 2-Hand safety protection
 Peso 2,2 Kg

• 94522

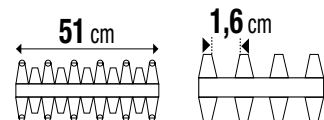



mod. TSP 61/20

Potenza 600 W - 230 V

Power 600 W -230 V

Lame a movimento contrapposto rinforzate

Double action blades, hardened

Lunghezza taglio cm 61

Cutting length cm 61

Diametro di taglio mm 20

Cutting diameter mm 20

Freno elettrico

Electric brake

Arresto immediato delle lame

Blades-brake device

Interruttore di sicurezza a due mani

2-Hand safety protection

Peso 2,5 Kg

Weight 2,5 Kg

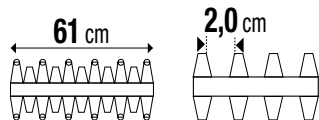

• 99010



8 000071 990103



1700 RPM

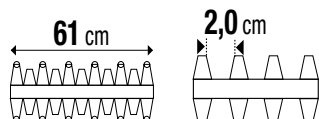

mod. TSG 61/20 N

Potenza 680 W - 230 V

Power 680 W -230 V

Lame a movimento contrapposto rinforzate

Double action blades, hardened

Lunghezza taglio cm 61

Cutting length cm 61

Diametro di taglio mm 20

Cutting diameter mm 20

Freno meccanico

Mechanical brake

Arresto immediato delle lame

Blades-brake device

Interruttore di sicurezza a due mani

2-Hand safety protection

Peso 3,4 Kg

Peso 3,4 Kg

• 94524



8 000071 945240

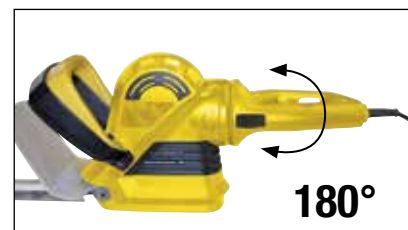

180°

Manico girevole / Revolving and adjustable handle



1700 RPM



tagliasiepi a motore gas hedge trimmers



mod. HT 25/55

Motore 2T - EURO 2 - 25,4 cc

Engine 2T - EURO 2 - 25,4 cc

Frizione centrifuga
 Carburatore a membrana con primer
 Dispositivo di limitazione automatica del regime dei giri all'avviamento (evita il funzionamento accidentale delle lame nella fase di messa in moto della macchina)
 Interruttore a leva con dispositivo di sicurezza sull'impugnatura posteriore
 Accensione elettronica
 Lama taglio bilaterale 550 mm
 Diametro taglio max 28 mm
 Maniglia frontale con piastra di protezione
 Impugnatura posteriore rotante a 3 posizioni 0° - 90° - 180°
 Capacità serbatoio 0,6 lt. - miscela 3%
 Peso 5,8 Kg

Centrifugal clutch
 Diaphragm carburetor
 Trigger level with built-in switch and safety lock device on rear handle
 Electronic ignition
 550 mm blade length, double cut
 Max cutting diameter 28 mm
 Turning function rear handle 3 positions: 0° - 90° - 180°
 Fuel tank 0,6 lt. - mixture 3%
 Weight 5,8 Kg

• 92446



Impugnatura a 3 posizioni / 3 position handle

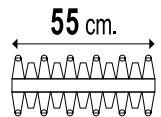

tagliasiepi tagliabordi a batteria cordless grass/lawn trimmer



mod. TSC 8/100 N

Batteria 7,2 volt litio - 1300 mAh

7,2 volt lithium battery - 1300 mAh

Utilizzo come cesoia per siepi e cesoia per prato
 Caricabatterie incluso da 3-5 h
 Durata batteria 50 min ca.

Grass shear and hedge trimmer use
 Battery charger 3-5 h included
 50 min ca battery time rating

Cesoia per prato:
 Larghezza taglio 100 mm

Grass shear:
 Cutting depth 100 mm

Cesoia per siepi:
 Ø max di taglio 8 mm
 Lunghezza lama 190 mm

Hedge trimmer:
 Ø max cutting 8 mm
 Blade length 190 mm

• 95111

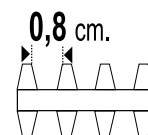
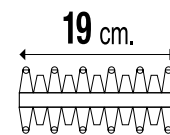
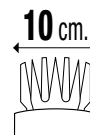

Prolunga telescopica (per codice 95111)
 Altezza 96 ÷ 133 cm
 Ruote regolabili su due altezze

Telescopic handle (for code 95111)
 Height 96 ÷ 133 cm
 Adjustable wheels to two heights

• 95112





mod. TB 280 XLN

Potenza 280 watt

Power 280 watt

Larghezza taglio 24 cm

Cutting width 24 cm

Testina 2 fili - Ø 1,2 mm

Two-cutting lines - Ø 1,2 mm

Avanzamento semi-automatico del filo

Semi-automatic line feed

Peso 2 Kg

Weight 2 Kg

• 99009



Testina di ricambio completa / Complete cutting head

• 96722



Rocchetto con filo / Nylon cutting line spool

• 96726



mod. TB 550

Potenza 550 watt

Power 550 watt

Larghezza taglio 29 cm

Cutting width 29 cm

Testina 2 fili - Ø 1,4 mm

Two-cutting lines - Ø 1,4 mm

Asta telescopica regolabile in altezza

Height adjustable telescopic handle

Testa di taglio orientabile a 90° e supporto ruota per tosare bordure

Edging function. 90° rotating cutter head with wheel support for edge trimming

Impugnatura regolabile

Adjustable handle

Avanzamento e regolazione automatica del filo

Automatic line feed adjustment

Archetto per la protezione delle piante

Plant protector

Peso 2,5 Kg

Weight 2,5 Kg

• 96719



Testina di ricambio completa / Complete cutting head

• 96723



Rocchetto con filo / Nylon cutting line spool

• 96725





tagliabordi elettrici electric lawn trimmers



mod. TB 1000

Motore 1000 watt

Power 1000 watt

Larghezza taglio 35 cm

Cutting width 35 cm

Testina 2 fili - Ø 2 mm

Two-cutting lines - Ø 2 mm

Sistema automatico uscita del filo

Automatic nylon head

Asta curva

Bent shaft

Peso 4,3 Kg

Weight 4,3 Kg

• 96720



Testina di ricambio completa / Complete cutting head

• 96724



Rocchetto con filo / Nylon cutting line spool

• 96727



decespugliatori brush cutters



EURO 2



mod. DG 33N

Motore 2T - Euro 2 - 32,6 cc

Engine 2T - Euro 2 - 32,6 cc

Carburatore a membrana

Diaphragm carburator

Marmitta catalizzata

Catalytic converter

Accensione elettronica

Electronic ignition

Frizione centrifuga automatica

Automatic centrifugal clutch

Capacità serbatoio 0,9 lt - miscela 2,5%

Fuel tank 0,9 lt - mixture 2,5%

Con staffa di protezione serbatoio

With fuel tank support

Fornito con testina tagliabordi e lama 3 denti

Furnished with nylon cutting head and 3 teeth blade

Peso 6,9 Kg

Weight 6,9 Kg

• 97843





EURO 2



mod. DG 43N

Motore 2T - Euro 2 - 42,7 cc

Engine 2T - Euro 2 - 42,7 cc

Carburatore a membrana
Marmitta catalizzata
Accensione elettronica
Frizione centrifuga automatica
Capacità serbatoio 1,1 lt - miscela 2,5%
Con staffa di protezione serbatoio
Fornito con testina tagliabordi e lama 3 denti
Peso 7,6 Kg

Diaphragm carburator
Catalytic converter
Electronic ignition
Automatic centrifugal clutch
Fuel tank 1,1 lt - mixture 2,5%
With fuel tank support
Furnished with nylon cutting head and 3 teeth blade
Weight 7,6 Kg

• 97844



8 000071 978446



EURO 2



mod. DG 52

Motore 2T - Euro 2 - 51,7 cc

Engine 2T - Euro 2 - 51,7 cc

Carburatore a membrana
Marmitta catalizzata
Accensione elettronica
Frizione centrifuga automatica
Capacità serbatoio 1,1 lt - miscela 2,5%
Con staffa di protezione serbatoio
Fornito con testina tagliabordi e lama 3 denti
Peso 7,7 Kg

Diaphragm carburator
Catalytic converter
Electronic ignition
Automatic centrifugal clutch
Fuel tank 1,1 lt - mixture 2,5%
With fuel tank support
Furnished with nylon cutting head and 3 teeth blade
Weight 7,7 Kg

• 97846



8 000071 978460



decespugliatori brush cutters



4 TEMPI
STROKE



mod. DG 4T-31

Motore 4T - 31 cc

Engine 4T - 31 cc

Carburatore a membrana
Accensione elettronica
Frizione centrifuga automatica
Capacità serbatoio 0,68 lt
Con staffa di protezione serbatoio
Fornito con testina tagliabordi e lama 3 denti
Peso 8,3 Kg

Diaphragm carburator
Electronic ignition
Automatic centrifugal clutch
Fuel tank 0,68 lt
With fuel tank support
Furnished with nylon cutting head and 3 teeth blade
Weight 8,3 Kg

• 99008



mod. POWER 43 E

Motore 2T - Euro2 - 42,7 cc

Engine 2T - Euro2 - 42,7 cc

Carburatore a membrana
Marmitta catalizzata
Accensione elettronica
Frizione centrifuga automatica
Capacità serbatoio 1,2 lt - miscela 4%
Con staffa di protezione serbatoio
Fornito con testina tagliabordi
Peso 8,1 Kg

Diaphragm carburator
Catalytic converter
Electronic ignition
Automatic centrifugal clutch
Fuel tank 1,2 lt - mixture 4%
With fuel tank support
Furnished with nylon cutting head
Weight 8,1 Kg

• 94687





mod. XY-BC415

Motore 2T - Euro 2 - 42,7 cc

Engine 2T - Euro 2 - 42,7 cc

Carburatore a membrana
Marmitta catalizzata
Accensione elettronica
Frizione centrifuga automatica
Capacità serbatoio 0,8 lt - miscela 2,5%
Con staffa di protezione serbatoio
Fornito con testina tagliabordi e lama 3 denti
Peso 10 Kg

Diaphragm carburator
Catalytic converter
Electronic ignition
Automatic centrifugal clutch
Fuel tank 0,8 lt - mixture 2,5%
With fuel tank support
Furnished with nylon cutting head and 3 teeth blade
Weight 10 Kg



• 96848



8 000071 968485



mod. DGB 52

Motore 2T - Euro 2 - 51,7 cc

Engine 2T - Euro 2 - 51,7 cc

Carburatore a membrana
Marmitta catalizzata
Accensione elettronica
Frizione centrifuga automatica
Capacità serbatoio 1,1 lt - miscela 2,5%
Fornito con testina tagliabordi e lama 3 denti
Peso 10,3 Kg

Diaphragm carburator
Catalytic converter
Electronic ignition
Automatic centrifugal clutch
Fuel tank 1,1 lt - mixture 2,5%
Furnished with nylon cutting head and 3 teeth blade
Weight 10,3 Kg



• 97847



8 000071 978477





decespugliatore multifunzione multifunction brush cutter



mod. MULTI CUTTER 33N

Motore 2T - Euro2 - 32,6 cc

- Carburatore a membrana
Marmitta catalizzata
Accensione elettronica
Frizione centrifuga automatica
Capacità serbatoio 0,9 lt - miscela 2,5%
Con staffa di protezione serbatoio
Diametro asta alluminio 26 mm
Il kit comprende 5 accessori:
- Lama 3 denti da decespugliatore
ampiezza taglio 255 mm (10")
spessore lama 1,4 mm
 - Testina filo nylon
ampiezza taglio 430 mm (17")
Ø filo 2,4 mm
 - Prolunga taglia siepi articolata
larghezza taglio 400 mm (16")
 - Sega potatrice - Catena e barra OREGON
lunghezza barra 254 mm (10")
con serbatoio di olio lubrificante
 - In dotazione asta di prolunga per patate 76 cm

Engine 2T - Euro2 - 32,6 cc

- Diaphragm carburator
Catalytic converter
Electronic ignition
Automatic centrifugal clutch
Fuel tank 0,9 lt - mixture 2,5%
With fuel tank support
Diameter aluminum Tube 26 mm
5 accessories:
- 3 teeth brush cutter blade
cut diameter 255 mm (10")
blade thickness 1,4 mm
 - Cutting head nylon
cut diameter 430 mm (17")
Ø cutting line 2,4 mm
 - Articulated hedge trimmer
cutting length 400 mm (16")
 - Chain saw pruner - Chain and bar OREGON
bar length 254 mm (10")
with oil tank
 - Extension pole combinat at the pruner 76 cm

• 97845



8 000071 978453

4 in 1



EURO 2



Tagliasiepi di ricambio per cod. 97845 e cod. 95464 (senza asta)
Hedge trimmer attachment for cod. 97845 and cod. 95464 (without shaft)

• 61650



8 000071 616508

Sega potatrice di ricambio per cod. 97845 e cod. 95464 (senza asta)
Chain saw bar attachment for cod. 97845 and cod. 95464 (without shaft)

• 61651



8 000071 616515



brush cutter blades **lame per decespugliatori**



Lama acciaio - 2 denti
Ø 255 mm

Steel blade - 2 teeth
Ø 255 mm

• 83737



Lama acciaio - 3 denti
Ø 255 mm
per tagli erba

Steel blade - 3 teeth
Ø 255 mm
for cutting grass

• 83736

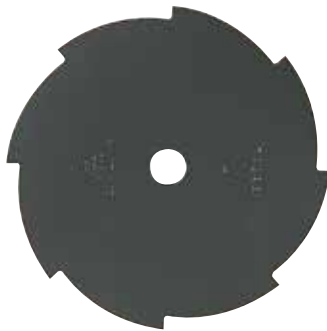

Lama acciaio - 8 denti
Ø 255 mm
per canneti, sterpi e felci

Steel blade - 8 teeth
Ø 255 mm
for cutting brushwood, ferns

• 80813



Lama acciaio - 40 denti
Denti al carburo di tungsteno
Ø 255 mm
Per il taglio di vegetazione mista fitta

Steel blade - 40 teeth
Tungsten carbide edged blade
Ø 255 mm
for cutting dense vegetation

• 94531

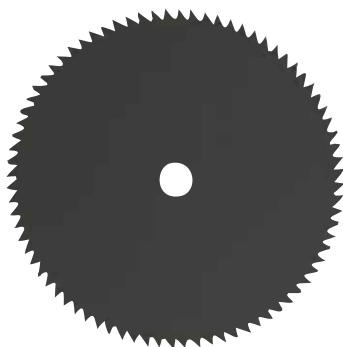

Lama acciaio - 80 denti
Ø 255 mm
per sottobosco

Steel blade - 80 teeth
Ø 255 mm
for underbrush

• 80811





testine cutting heads

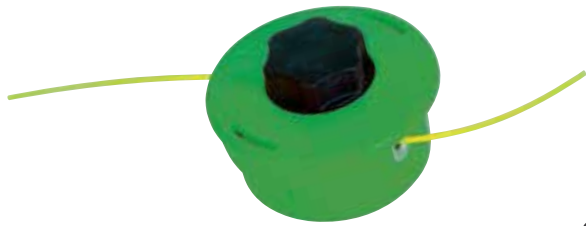

CE



Testina batti e vai
Alta capacità di filo
Con filo nylon Ø 3,0 mm
Carica esterna del filo
Attacco universale

"Bumps & go" head
High capacity
With cutting line Ø 3,0 mm
Cutting line with external charging
Universal connection

55413



8 000071 554138



CE



Testina batti e vai
Alta capacità di filo
Con filo nylon Ø 3,0 mm
Attacco universale

"Bumps & go" head
High capacity
With cutting line Ø 3,0 mm
Universal connection

54600



8 000071 546003



CE



Testina universale multifilo
Corpo in polimero ad alta resistenza
Filo nylon Ø 3,0 mm
Ghiera in alluminio
Antivibrazione
Attacco universale

Universal heads multiline
High resistance polymer body
Cutting line 3,0 mm
Alluminium boss
Antivibration
Universal connections

54691



8 000071 546911



CE



Testina universale multifilo
Corpo in alluminio
Con 8 fili nylon Ø 2,4 mm
Regolazione automatica
Attacco universale

Universal heads multiline
Alluminium body
With 8 cutting lines Ø 2,4 mm
Automatic setting
Universal connection

55627



8 000071 556279



Profilo a stella Confezione 15 metri		Star section 15 m length
• 83146	ø 2,4 mm	8 000071 831468
• 83147	ø 3,0 mm	8 000071 831475
Profilo quadro Confezione 10 metri		Square section 10 m length
• 85859	ø 2,4 mm	8 000071 858595
• 85860	ø 3,0 mm	8 000071 858601
Profilo tondo Confezione 15 metri		Round section 15 m length
• 99092	ø 1,3 mm	8 000071 990929
• 81744	ø 1,6 mm	8 000071 817448
• 80817	ø 2,0 mm	8 000071 808170
• 80818	ø 2,4 mm	8 000071 808187
• 80820	ø 3,0 mm	8 000071 808200



Profilo a stella / Star section		
• 83206	ø 3,0 mm x 50 m	8 000071 832069
Profilo tondo / Round section		
• 80821	ø 2,4 mm x 100 m	8 000071 808217
• 80822	ø 3,0 mm x 50 m	8 000071 808224
Profilo quadro / Square section		
• 85862	ø 3,0 mm x 50 m	8 000071 858625





filo nylon nylon cutting line



mod. PROFESSIONAL

Conf. su disco dispenser

Drum dispenser

Profilo tondo / Round section

• **87865** ø 3,0 mm x 9 m 8 000071 878654

• **87866** ø 3,5 mm x 7 m 8 000071 878661

• **87867** ø 3,0 mm x 55 m 8 000071 878678

• **87868** ø 3,5 mm x 42 m 8 000071 878685

Profilo quadro / Square section

• **87871** ø 3,0 mm x 53 m 8 000071 878715

• **87872** ø 3,5 mm x 34 m 8 000071 878722

• **87873** ø 4,0 mm x 31 m 8 000071 878739



mod. PROFESSIONAL

Con particelle di alluminio

Aluminium particle

Conf. su disco dispenser

Drum dispenser

Profilo tondo / Round section

• **99093** ø 3,0 mm x 50 m 8 000071 878654

• **99095** ø 3,5 mm x 40 m 8 000071 878661

Profilo quadro / Square section

• **99094** ø 3,0 mm x 50 m 8 000071 878654

• **99096** ø 3,5 mm x 40 m 8 000071 878661





mod. OS 1000

Potenza 140 watt

Power 140 watt

Doppio pettine

Double rake

Alimentazione tramite batteria da 12 volt (batteria non inclusa)

Operating voltage 12 volt (battery is not included)

Frequenza battiti 1000 rpm

Beat frequency 1000 rpm

Asta telescopica

Telescopic handle

Lunghezza 2÷3 metri

Length 2÷3 m

Cavo collegamento 15 metri

Power cable 15 m

Peso 4,0 Kg

Weight 4,0 Kg

• 96235



Larghezza pettini 260 mm
Rake width 260 mm

CE





elettroseghe electric chain saw

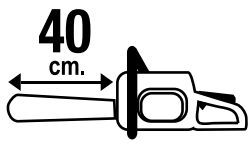

mod. ES 18/40

Potenza 1800 watt

Power 1800 watt

Lunghezza barra guida 40 cm (16")
Freno catena automatico
Velocità catena 13,5 m/sec
Lubrificazione automatica
Pomello tendicatena esterno
Peso 5 Kg

Length of guide bar 40 cm (16")
Automatic chain brake
Chain speed 13,5 m/sec
Automatic lubrication
Outside chain stretch knob
Weight 5 Kg

• 99011



Barra di ricambio / Guide bar

• 99029



Catena di ricambio / Saw

• 99013

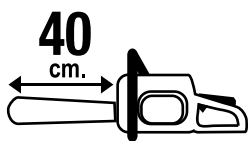

mod. ESN 23/40

Potenza 2300 watt

Power 2300 watt

Lunghezza barra guida 40 cm (16")
Catena e barra Oregon
Freno catena automatico
Velocità catena 15 m/sec
Lubrificazione automatica
Pomello tendicatena esterno
Peso 4,6 Kg

Length of guide bar 40 cm (16")
Saw chain Oregon
Automatic chain brake
Chain speed 15 m/sec
Automatic lubrication
Outside chain stretch knob
Weight 4,6 Kg

• 99012





Motore in asse con la barra



mod. ESD 20/40 N

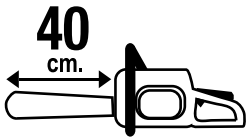

Potenza 2200 watt

Power 2200 watt

Lunghezza barra guida 40 cm (16")

Length of guide bar 40 cm (16")

Catena e barra Oregon

Saw Chain Oregon

Freno catena automatico

Automatic chain brake

Velocità catena 15 m/sec

Chain speed 15 m/sec

Lubrificazione automatica

Automatic lubrication

Pomello tendicatena esterno

Outside chain stretch knob

Peso 5,4 Kg

Weight 5,4 Kg

• 94451



Barra + Catena di ricambio (per cod. 94451 e 99012) / Guide bar + Saw (per cod. 94451 and 99012)

• 61537





motoseghe da pota chain saw pruner



ranger25

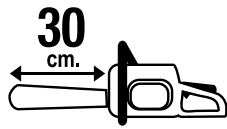

Carburatore WALBRO



mod. RANGER 25

Motore 2T - Euro2- 25,4 cc

Engine 2T - Euro2- 25,4 cc

Capacità serbatoio 0,20 lt
 Miscela 3%
 Serbatoio olio catena 0,14 lt
 Lunghezza barra guida 30 cm (12")
 Carburatore WALBRO
 Catena OREGON
 Peso 3,2 Kg (senza barra e catena)
 Pratica custodia con manici

Fuel tank 0,20 lt
 Mixture 3%
 Chain oil tank 0,14 lt
 Length of guide bar 30 cm (12")
 WALBRO carburetor
 OREGON chain
 Weight 3,2 Kg (without chain & bar)
 Easy bag with handles

• 92831



• 61597

Barra di ricambio



• 61598

Catena OREGON di ricambio



GREEN SAW 25



mod. GREEN SAW 25

Motore 2T - Euro2 -25,4 cc

Engine 2T - Euro2 - 25,4 cc

Capacità serbatoio 0,23 lt
 Miscela 4% (25:1)
 Serbatoio olio catena 0,16 lt
 Lunghezza barra guida 25 cm
 Peso 2,9 Kg (senza barra e catena)

Fuel tank 0,23 lt
 Mixture 4% (25:1)
 Chain oil tank 0,16 lt
 Length of guide bar 25 cm
 Weight 2,9 Kg (without chain & bar)

• 94740

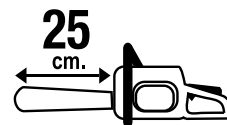



ranger 39

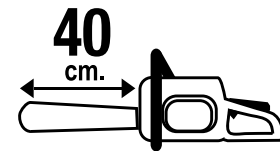

EURO 2



mod. RANGER 39

Motore 2T - Euro2 - 37,2 cc

Engine 2T - Euro 2 - 37,2 cc

Capacità serbatoio 0,31 lt
Miscela 2% (50:1)
Frizione centrifuga
Carburatore a membrana
Accensione elettronica
Impugnatura antivibrante
Freno catena inerziale
Lubrificazione catena automatica
Serbatoio olio catena 0,21 lt
Barra Oregon catena 40 cm (16")
Catena Oregon 91VG 3/8" x 0,05
Peso senza barra e catena 4,15 Kg

Fuel tank 0,31 lt
Mixture 2% (50:1)
Centrifugal clutch
Diaphragm carburetor
Electronic ignition
Antivibration handle
Inertial chain brake
Automatic chain lubrication
Chain oil tank 0,21 lt
Chain bar Oregon 40 cm (16")
Saw chain Oregon 91VG 3/8" x 0,05
Weight without bar and chain 4,15 Kg

• 92769



8 000071 927697

• 61599

Barra OREGON di ricambio



8 000071 615990

• 61600

Catena OREGON di ricambio



8 000071 616003



mod. RANGER 46

Motore 2T - Euro2 - 45 cc

Engine 2T - Euro 2 - 45 cc

Capacità serbatoio 0,55 lt
Miscela 4% (25:1)
Frizione centrifuga
Carburatore a membrana
Accensione elettronica
Impugnatura antivibrante
Freno catena inerziale
Lubrificazione catena automatica
Serbatoio olio catena 0,26 lt
Carburatore WALBRO
Barra Oregon catena 45 cm (18")
Catena Oregon 21VB 0,325 x 0,05
Peso senza barra e catena 5,4 Kg

Fuel tank 0,55 lt
Mixture 4% (25:1)
Centrifugal clutch
Diaphragm carburetor
Electronic ignition
Antivibration handle
Inertial chain brake
Automatic chain lubrication
Chain oil tank 0,26 lt
WALBRO carburetor
Chain bar Oregon 45 cm (18")
Saw chain Oregon 21VB 0,325 x 0,05
Weight without bar and chain 5,4 Kg

• 94120



8 000071 941204

• 61601

Barra OREGON di ricambio



8 000071 616010

• 61602

Catena OREGON di ricambio



8 000071 616027



ranger 46

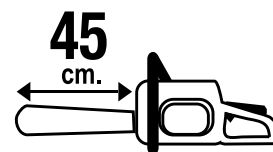

Carburatore WALBRO



EURO 2



affilcatene chain saw grinder



YAMATO

mod. AC 100

Potenza 180 watt - 230 V

Power 180 watt - 230V

Giri al minuto 6300 rpm
 Ø disco abrasivo 100 mm x 3,2 mm
 Base in alluminio pressofuso
 Peso 3 Kg

Speed 6300 rpm
 Ø disc 100 mm x 3,2 mm
 Aluminium die casting base
 Weight 3 Kg

• 94507



Mole di ricambio per cod. 94507 / Grinding stone replacement for code 94507

• 61527

100 x 3,2 mm



• 61528

100 x 4,5 mm



spaccalegna elettrici electric log splitters



CE IP54

papillon

mod. LS5T-52 A

Potenza 1500 watt - 230 V

Power 1500 watt - 230 V

Capacità di spinta 5 ton
 Ø max tronco 5~25 cm
 Lunghezza max tronco 52 cm
 Peso 50 Kg
 Dimensioni 94x26x48 cm
 Classe isolamento IP 54

Press capacity 5 ton
 Ø max log capacity 5~25 cm
 Max log length 52 cm
 Weight 50 Kg
 Dimension 94x26x48 cm
 Insulated class IP 54

• 95452



CE IP54

papillon

mod. VLS7T

Potenza 3000 watt - 230 V

Power 3000 watt - 230 V

Capacità di spinta 7 ton
 Ø max tronco 7~40 cm
 Lunghezza max tronco 106/77/58 cm
 Piano di lavoro 38x28 cm
 Peso 98 Kg
 Dimensioni 83x93x145 cm
 Classe isolamento IP 54
 Cuneo a croce in dotazione

Press capacity 7 ton
 Ø max log capacity 7~40 cm
 Max log length 106/77/58 cm
 Table surface 38x28 cm
 Weight 98 Kg
 Dimension 83x93x145 cm
 Insulated class IP 54
 Splitting wedge included

• 95453





YAMATO

mod. G800 - 2T

Motore 2T - 63 cc

Engine 2T - 63 cc

Potenza nominale 0,65 kW
Potenza max 0,8 kW
Caricabatterie
Carburante miscela 2,5%
Capacità serbatoio 4 lt.
Dimens. 370x310x320 mm
Peso 17 Kg

Rated power 0,65 kW
Max power 0,8 kW
Battery charger
Mixture 2,5%
Fuel tank 4 lt
Dimens. 370x310x320 mm
Weight 17 Kg

• 94716



YAMATO

mod. G2200 - 4T

Motore 4T - 196 cc

Engine 4T - 196 cc

Potenza nominale 2 kW
Potenza max 2,2 kW
Con regolatore automatico di tensione (AVR)
Caricabatterie
Capacità serbatoio 15 lt.
Capacità serbatoio olio 0,37 lt.
Dimens. 590x430x435 mm
Peso 42 Kg

Rated power 2 kW
Max power 2,2 kW
With automatic voltage regulator (AVR)
Battery charger
Fuel tank 15 lt.
Oil fuel tank 0,37 lt
Dimens. 590x430x435 mm
Weight 42 Kg

• 94717



YAMATO

mod. G3300 - 4T

Motore 4T - 270 cc

Engine 4T - 270 cc

Potenza nominale 3 kW
Potenza max 3,3 kW
Con regolatore automatico di tensione (AVR)
Caricabatterie
Capacità serbatoio 25 lt.
Capacità serbatoio olio 1 lt.
Dimens. 680x515x550 mm
Peso 62 Kg

Rated power 3 kW
Max power 3,3 kW
With automatic voltage regulator (AVR)
Battery charger
Fuel tank 25 lt.
Oil fuel tank 1 lt.
Dimens. 680x515x550 mm
Weight 62 Kg

• 94718



YAMATO

mod. G5500 - 4T

Motore 4T - 389 cc

Engine 4T - 389 cc

Potenza nominale 5 kW
Potenza max 5,5 kW
Con regolatore automatico di tensione (AVR)
Caricabatterie
Capacità serbatoio 25 lt.
Capacità serbatoio olio 1 lt.
Dimens. 680x515x550 mm
Peso 82 Kg

Rated power 3 kW
Max power 5,5 kW
With automatic voltage regulator (AVR)
Battery charger
Fuel tank 25 lt.
Oil fuel tank 1 lt.
Dimens. 680x515x550 mm
Weight 82 Kg

• 94719





accessori accessories

100% vegetale**papillon**

Olio per catene / Chain saw lubricant

53709

1 Litro

**50711**

5 Litri

**100% sintetico****ADDITIVATO****papillon**

Olio per motore a 2 tempi / 2T Motor oil

52119

100 ml

**99219**

1 Litro



Lubrificante completamente sintetico a base estere, specificatamente formulato per motori a due tempi d'ultima concezione. Idoneo per scooter, motoslitte, motori marini e per tutti i motori due tempi per il giardinaggio quali motoseghe, tagliaerba, decespugliatori ecc.

Si utilizza diluendolo istantaneamente nella benzina verde, nella super plus e nelle benzine da competizione nella concentrazione prescritta dal costruttore.

**papillon**

Olio per motore a 4 tempi / 4T Motor oil

53711

600 ml

**papillon**

Olio per motore a 4 tempi 15W-40 / 4T 15W-40 Motor oil

99221

1 Litro

**99222**

4 Litri

**LUBRIFICANTE DI ALTA QUALITÀ PER MOTORI BENZINA e DIESEL**

Lubrificante universale multigrado per la lubrificazione di tutti i tipi di motori in tutte le stagioni. Realizzato con materie prime altamente selezionate e formulato per fornire ottime prestazioni in motori a benzina e diesel, aspirati o turbo, garantendo la massima protezione.

L'olio motore 15W-40 presenta una serie di additivi che assicurano una buona pulizia del motore e una elevata protezione contro l'usura dei componenti meccanici, anche in condizione di impiego gravoso.



CANDELE SPARK PLUGS	
51736	per motoseghe / chain saw
51737	per rasaerba / lawn mowers
51738	per decespugliatori / brush cutters
54453	per motori Honda / Honda engine



cans **taniche**



MAURER

Taniche ferro
Protette internamente
Omologate TÜV

Metal Jerry cans
Inner coating
TÜV approved

85949	5 litri	
80094	10 litri	
80095	20 litri	

MAURER

Taniche in plastica
Per benzina verde
Approvato UN
Fornite di beccuccio

Plastic cans
For unleaded petrol
UN approved
With spout

54692	5 litri	
54693	10 litri	
91870	20 litri	



MAURER

Beccuccio per taniche in metallo / Rigid spout

83489	
--------------	--



occhiali protezione safety goggles



CE

© EN166 F 2-1.2 © 1F



CE

© EN166 F 5-2.5 © 1FO



CE

© EN166 F 2-1.2 © 1FO

MAURER
PLUS

Occhiali con stanghette regolabili / Goggles with adjustable side-pieces

• 92655	Lenti trasparenti / Transparent	
• 89046	Lenti grigie / Grey lens	
• 89047	Lenti giallo ambra / Yellow amber lens	



© 1F EN166 F © 1FO

CE

MAURER
PLUS

Occhiali con stanghette allungabili / Goggles with extensible side-pieces

• 88339	Lenti trasparenti / Transparent	
---------	---------------------------------	---



© EN166 F 2-1.2 © 1F

CE



BB EN166 F CE 5-3.1 BB 1 F

CE



BB EN166 FT CE 2C-1.2 BB 1 FT

CE

MAURER
PLUS

Occhiali con stanghette fisse / Goggles with not adjustable side-pieces

• 92689	Lenti trasparenti / Transparent	
• 96944	Lenti grigie / Grey lens	

+ Nasello e copertura stanghette in silicone / + Soft nose bridge

• 96943	Lenti trasparenti avvolgenti / Wraparound transparent lens	
---------	--	---

+ Telaio in gomma e plastica / + Rubber and plastic frame

• 93143	Lenti trasparenti avvolgenti / Wraparound transparent lens	
---------	--	---



BB EN166 F CE 2-1.2 BB 1 F CE



MAURER
PLUS

Occhiali con stanghette flessibili

Ultraleggeri

Struttura priva di metalli (Metal-free)

Goggles with stretchables side-pieces

Super light weight

Metal-free construction

• 99347

Lenti trasparenti / Transparent



BB EN166 F CE 2C-1.2 BB 1 F CE



MAURER
PLUS

Occhiali con stanghette fisse

sovrapponibili agli occhiali da vista

Goggles with not adjustable side-pieces

fits over regular prescription glasses

• 87360

Lenti trasparenti / Transparent



© 1F EN166



MAURER
PLUS

Occhiali panoramici lenti neutre

con elastico

Goggles polycarbonate lens

with rope

• 80195

Aerazione con fori / Direct ventilation



• 83985

Aerazione con valvole / Ventilation valves



© EN166 B

© 1B0



© EN166 3 4 9B

© 1B90



MAURER
PLUS

Occhiali a mascherina lenti neutre

con elastico

Goggles mask polycarbonate lens

with rope

• 93142

Aerazione con fori / Direct ventilation



BB EN166 B 3 CE

2-1.2 BB 1 B CE





visiere di protezione face shield



• 82585	Modello fisso in policarbonato Polycarbonate fixed type	 8 000071 825856
• 82586	Modello ribaltabile in policarbonato Polycarbonate adjustable type	 8 000071 825863
• 82587	Modello ribaltabile in rete Wire mesh adjustable type	 8 000071 825870



cuffie e tappi auricolari ear muffs



SNR 34 dB



Tappi auricolari
Monouso ad espansione

Earplugs
Disposable, expandable foam

• 95450



SNR 34 dB



Tappi auricolari
Monouso ad espansione
Con cordino

Earplugs
Disposable, expandable foam
With cord

• 95451



SNR 28 dB



Cuffie antirumore
Pieghevoli
Archetto regolabile e imbottito

Ear muffs
Foldable
Adjustable padded headband

• 94005





SNR 26 dB



MAURER

Cuffie antirumore
Archetto regolabile

Ear muffs
Adjustable headband

• 80923



MAURER

Tris protezione
Mascherina + occhiali + cuffia

Safety set
mask + goggles + ear muffs

• 89152



MAURER PLUS

Classe protezione FFP 1

Class protection FFP 1

• 88573

blister 5 pz



• 87200

conf. 20 pz



MAURER PLUS

Classe protezione FFP 1
Con valvola

Class protection FFP 1
With valve

• 88574

blister 3 pz



• 87201

conf. 10 pz



* Tutti i modelli MAURER PLUS sono conformi alla Normativa Europea EN 149:2001 + A1:2009



mascherine protezione dust masks



CE



CE

MAURER
PLUS

Classe protezione FFP 1
Ai carboni attivi

Class protection FFP 1
Active carbon

• 88575

blister 4 pz



8 000071 885751

• 87202

conf. 20 pz



8 000071 872027

MAURER
PLUS

Classe protezione FFP 1
Con valvola e carboni attivi

Class protection FFP 1
With valve and active carbon

• 88576

blister 3 pz



8 000071 885768

• 87203

conf. 10 pz



8 000071 872034



CE



CE

MAURER
PLUS

Classe protezione FFP 2

Class protection FFP 2

• 87204

conf. 20 pz



8 000071 872041

MAURER
PLUS

Classe protezione FFP 2
Con valvola

Class protection FFP 2
With valve

• 87205

conf. 10 pz



8 000071 872058

CE



MAURER
PLUS

Classe protezione FFP 3
Con valvola

Class protection FFP 3
With valve

• 89730

conf. 5 pz



8 000071 897303

NR D : Le maschere hanno superato i test di resistenza all'intasamento con polvere Dolomite (D). Non riutilizzabile (NR).



CE



CE

MAURER
PLUS

Classe protezione FFP 2
Pieghevoli con valvola

Class protection FFP 2
Foldable with valve

• 92751

conf. 10 pz



MAURER
PLUS

Classe protezione FFP 3
Pieghevoli con valvola

Class protection FFP 3
Foldable with valve

• 92752

conf. 10 pz



CE



CE

MAURER
PLUS

Classe protezione FFP 1 NR D
Struttura in plastica rigida
Con valvola

Class protection FFP 1 NR D
Rigid plastic structure
With valve

• 93738

conf. 5 pz



MAURER
PLUS

Classe protezione FFP 2 NR D
Struttura in plastica rigida
Con valvola

Class protection FFP 2 NR D
Rigid plastic structure
With valve

• 93739

conf. 5 pz



NR D : Le maschere hanno superato i test di resistenza all'intasamento con polvere Dolomite (D). Non riutilizzabile (NR).



MAURER

Mascherine igieniche
In fibra sintetica pressata
Con stringinaso
Ideali per hobby e bricolage

Non-toxic particle masks
Made of non-woven fabric molded
With nosepiece
Suitable for hobby and DIY

• 81078

Confezione 10 pezzi



• 80196

Confezione 50 pezzi





guanti gloves



MAURER

mod. FLO-GRIP

Spalmatura in lattice verde

Finitura microporosa

Filato in poliestere senza cuciture

Green foam latex coated gloves

Micropore finish

White polyester seamless liner

• 98895

taglia / size 6



• 98896

taglia / size 7



• 98897

taglia / size 8



• 98898

taglia / size 9



MAURER

mod. HI-GRIP

Spalmatura in lattice nero

Finitura microporosa

Filato in poliestere giallo senza cuciture

Black foam latex coated gloves

Micropore finish

Yellow polyester seamless liner

• 98892

taglia / size 8



• 98893

taglia / size 9



• 98894

taglia / size 10



MAURER

mod. WINTER

Spalmatura in lattice nero

Guanto in acrilico imbottito

Per la stagione fredda

Black foam latex coated gloves

Acrylic seamless liner

For cold weather

• 94388

taglia / size 8



• 94389

taglia / size 9



• 94390

taglia / size 10



MAURER

mod. GRIP-FLEX

Spalmatura in lattice nero

Finitura zigrinata

Filato in nylon rosso senza cuciture

Black foam latex coated gloves

Crinkle finish

Red nylon seamless liner

• 98899

taglia / size 8



• 98900

taglia / size 9



• 98901

taglia / size 10





CE
EN 388
EN 420



MAURER

mod. GLOVEX

Spalmatura in nitrile grigio

Filato in poliestere bianco senza cuciture

Grey nitrile coated gloves

White polyester seamless liner

• 98877	taglia / size 8	8 000071 988773
• 98878	taglia / size 9	8 000071 988780
• 98879	taglia / size 10	8 000071 988797



CE
EN 388
EN 420



MAURER

mod. GLOVEX

Spalmatura in nitrile grigio

Filato in poliestere nero senza cuciture

Grey nitrile coated gloves

Black polyester seamless liner

• 98880	taglia / size 8	8 000071 988803
• 98881	taglia / size 9	8 000071 988810
• 98882	taglia / size 10	8 000071 988827

MAURER

mod. NITROFIT

Spalmatura in nitrile grigio

Filato in nylon grigio senza cuciture

Grey nitrile coated gloves

Grey nylon seamless liner

• 94382	taglia / size 8	8 000071 943826
• 94383	taglia / size 9	8 000071 943833
• 94384	taglia / size 10	8 000071 943840

CE
EN 388



MAURER

mod. NITRODOT

Spalmatura in nitrile nero

Puntinatura in PVC su palmo e dita

Filato in nylon grigio senza cuciture

Black nitrile coated gloves

Dotted Grip Palm

Grey nylon seamless liner

• 98889	taglia / size 8	8 000071 988896
• 98890	taglia / size 9	8 000071 988902
• 98891	taglia / size 10	8 000071 988919

CE
EN 388





guanti gloves



MAURER mod. G-LIGHT

Guanto ultraleggero Superlight gloves
Spalmatura in poliuretano nero Black polyurethane coated gloves
 Guanto in poliestere blu senza cuciture Blue polyester seamless liner

• 98902	taglia / size 8	8 000071 989022
• 98903	taglia / size 9	8 000071 989039
• 98904	taglia / size 10	8 000071 989046



MAURER mod. SEATTLE

Spalmatura in poliuretano bianco White polyurethane coated gloves
 Filato in poliestere bianco senza cuciture White polyester seamless liner

• 98883	taglia / size 8	8 000071 988834
• 98884	taglia / size 9	8 000071 988841
• 98885	taglia / size 10	8 000071 988858



MAURER mod. SEATTLE

Spalmatura in poliuretano grigio Grey polyurethane coated gloves
 Filato in poliestere grigio senza cuciture Grey polyester seamless liner

• 98886	taglia / size 8	8 000071 988865
• 98887	taglia / size 9	8 000071 988872
• 98888	taglia / size 10	8 000071 988889



MAURER mod. SEATTLE II - Touch

Spalmatura in poliuretano Polyurethane coated gloves
 Filato in nylon giallo senza cuciture Yellow polyester seamless liner
 Colore giallo alta visibilità Hi-vis yellow color
 Tre dita con funzione Touch screen With Touch screen function

• 97683	taglia / size 8	8 000071 976831
• 97684	taglia / size 9	8 000071 976848
• 97685	taglia / size 10	8 000071 976855



MAURER

Guanto in pelle con dorso in tessuto Grain leather glove fabric back
Chiusura a strappo Adjustable wrist

• 98708	taglia / size 8	8 000071 988995
• 98709	taglia / size 9	8 000071 989008
• 98710	taglia / size 10	8 000071 989015



MAURER

TUTA USA E GETTA

Tuta usa e getta Disposable coveralls
Colore bianco White colour
100% polipropilene Tessuto-non-tessuto 100% polypropylene TNT
Impermeabile all'acqua e all'aria Air-water proof
Trattamento antistatico Antistatic
Con cappuccio With hood
Polsini e caviglie con elastico Elastic cuff and ankle

• 88513	L	8 000071 885133
• 88514	XL	8 000071 885140
• 88515	XXL	8 000071 885157





calzature di sicurezza safety shoes



Tomaia: Pelle Nabuk Hydrotech con crosta scamosciata bottalata.
Fodera: Aired 3D 320 gr/m² con inserto antiusura sul tallone Dual Micro.
Suola: PU/PU con battistrada nero.
Soletta: Soft Fit, traspirante, antistatica, assorbente.
Puntale: In alluminio ALU-SXT.
Lamina: in composito multistrato ZERO (K) resistente ad una forza di 1100N con 0 mm di perforazione secondo normativa EN 12568.

MAURER PLUS

mod. AKEMAN S1-P

95140	38	8 000071 951401
95141	39	8 000071 951418
95142	40	8 000071 951425
95143	41	8 000071 951432
95144	42	8 000071 951449
95145	43	8 000071 951456
95146	44	8 000071 951463
95147	45	8 000071 951470
95148	46	8 000071 951487

CE Calzature di sicurezza conformi alla normativa europea EN ISO 20345:2011



Tomaia: Crosta Scamosciata bottalata col. Taupe e inserti in tessuto indemagliabile Mesh HT .
Fodera: Aired 3D 320 gr/m² con inserto antiusura sul tallone Dual Micro.
Suola: Poliuretano bi-densità nero – para trasparente.
Soletta: "Blowfit" anatomico in Fusstatic, antistatico,assorbente, antibatterico ai carboni attivi, con inserto di supporto "shock absorber" in "EVA".
Puntale: In materiale composito CTC resistente a 200 Joule.
Lamina: In composito multistrato ZERO (K) resistente ad una forza di 1100 N con 0 mm di perforazione EN12568.

MAURER PLUS

mod. AURELIA S1-P

92041	38	8 000071 920414
92042	39	8 000071 920421
92043	40	8 000071 920438
92044	41	8 000071 920445
92045	42	8 000071 920452
92046	43	8 000071 920469
92047	44	8 000071 920476
92048	45	8 000071 920483
92049	46	8 000071 920490

CE Calzature di sicurezza conformi alla normativa europea EN ISO 20345:2011



MAURER

mod. SUTTON S1-P

• 97130	38	8 000071 971300
• 97131	39	8 000071 971317
• 97132	40	8 000071 971324
• 97133	41	8 000071 971331
• 97134	42	8 000071 971348
• 97135	43	8 000071 971355
• 97136	44	8 000071 971362
• 97137	45	8 000071 971379
• 97138	46	8 000071 971386



Tomaia: Pelle crosta scamosciata .

Fodera: Tessuto nylon + mesh.

Suola: In gomma.

Soletta: "Schiumato", antistatico, assorbente.

Puntale: In materiale composito resistente a 200 Joule.

Lamina: Antiperforazione in tessuto a norma EN ISO 20345:2011 resistente ad una forza di penetrazione di 1100 Newton.



Calzature di sicurezza conformi alla normativa europea EN ISO 20345:2011

MAURER

mod. SEWARD S1-P

• 95160	38	8 000071 951609
• 95161	39	8 000071 951616
• 95162	40	8 000071 951623
• 95163	41	8 000071 951630
• 95164	42	8 000071 951647
• 95165	43	8 000071 951654
• 95166	44	8 000071 951661
• 95167	45	8 000071 951678
• 95168	46	8 000071 951685



Tomaia: Pelle crosta scamosciata .

Fodera: Tessuto nylon + mesh.

Suola: In gomma.

Soletta: "Schiumato", antistatico, assorbente.

Puntale: In materiale composito resistente a 200 Joule.

Lamina: Antiperforazione in tessuto a norma EN ISO 20345:2011 resistente ad una forza di penetrazione di 1100 Newton.



Calzature di sicurezza conformi alla normativa europea EN ISO 20345:2011



calzature di sicurezza safety shoes



Tomaia: 3D KPU MESH in tessuto termoplastico microstampato senza cuciture, offre traspirabilità e flessibilità, senza rinunciare alla stabilità e garantendo un'elevata resistenza all'abrasione.

Fodera: Tessuto nylon.

Suola: in gomma EVA, caratterizzata da proprietà antistatiche e protezione antiscivolo su macchie d'olio. Ottimo assorbimento di energia nella zona del tallone

Soletta: "Schiumato", antistatico, assorbente.

Puntale: In materiale composito resistente a 200 Joule.

Lamina: Antiperforazione in tessuto a norma EN ISO 20345:2011 resistente ad una forza di penetrazione di 1100 Newton.

MAURER

mod. VICTRIX S1-P SRC

• 98210	38	
• 98211	39	
• 98212	40	
• 98213	41	
• 98214	42	
• 98215	43	
• 98216	44	
• 98217	45	
• 98218	46	

Calzature di sicurezza conformi alla normativa europea EN ISO 20345:2011

stivali boots



MAURER

STIVALI CANADESI

Materiale termoplastico
Interno pelliccia sintetica
Trattamento Teflon® con proprietà idrorepellenti
Ganci antiruggine
Doppie cuciture alta tenacità

Thermoplastic material
Synthetic fur interior
Owned water Teflon® treatment
Rustproof hooks
High-toughness double seams

92878	39	
92879	40	
92880	41	
92881	42	
92882	43	
92883	44	
92884	45	
92885	46	



MAURER

STIVALI CANADESI

Materiale termoplastico	Thermoplastic material
Interno pelliccia sintetica	Synthetic fur interior
Galoscia idrorepellente	Waterproof rubber shell
Tomaia in tessuto idrorepellente	Upper in water-repellent fabric
Ganci antiruggine	Rustproof hooks
Doppie cuciture alta tenacità	High-toughness double seams
98473	39 
98474	40 
98475	41 
98476	42 
98477	43 
98478	44 
98479	45 
98480	46 



MAURER

STIVALI PVC

Stivali di sicurezza	Safety boots
Puntale acciaio	Toecap in steel
Lamina acciaio antiforo	Antiperforation sole steel
Suola carrarmato	Sculptured sole
A ginocchio	Half type
97447	38 
53242	39 
53243	40 
53244	41 
53245	42 
53246	43 
53247	44 
53248	45 
53249	46 



EN ISO 20345:2011 S5



stivali boots



STIVALI GOMMA

Stivali in gomma - A tronchetto		Rubber - Top type	
53224	39	53228	43
53225	40	53229	44
53226	41	53230	45
53227	42	53231	46
Stivali in gomma - A ginocchio		Rubber - Knee type	
53232	39	53236	43
53233	40	53237	44
53234	41	53238	45
53235	42	53239	46

EN ISO 20347:2012 OB E SRA



EN ISO 20347:2012 OB E SRA



STIVALI PVC

Stivali in PVC - A tronchetto		PVC - Top type	
97679	36	50477	42
97680	37	50478	43
97743	38	50479	44
50474	39	50480	45
50475	40	50481	46
50476	41	97744	47

STIVALI PVC

Stivali in PVC - A ginocchio		PVC - Knee type	
97681	36	88686	42
97682	37	88687	43
97445	38	88688	44
88683	39	88689	45
88684	40	88690	46
88685	41	97446	47

calzature shoes



ZOCCOLI PVC

54958	35 / 36	53587	41 / 42
54959	37 / 38	53589	43 / 44
53585	39 / 41	53591	45 / 46



UTENSILI GIARDINAGGIO



CATALOGO
GIARDINAGGIO
2017



ACCIAIO CROMATO



Trapiantatore largo / Trowel
• 83641
8 000071 836418



Trapiantatore stretto / Transplantner
• 83640
8 000071 836401



Rastrello 4 denti / 4 teeth rake
• 85865
8 000071 858656



Zappetta cuore-tridente
Hoe heart-trident
• 83642
8 000071 836425



Zappetta quadra-tridente
Hoe square-trident
• 83643
8 000071 836432



Foraterra / Dibble
• 83646
8 000071 836463



Piantabulbi a espansione
Bulb planter
• 83106
8 000071 831062



ACCIAIO VERNICIATO

Acciaio verniciato - manico legno spugna / Heavy duty - powder coating finish - wooden handle with foam



Trapiantatore largo / Trowel

• 98202



8 000071 982023



Trapiantatore stretto / Transplantner

• 98203



8 000071 982030



Zappetta cuore-tricornia
Hoe heart-trident

• 98206



8 000071 982061



Zappetta quadra-bicornia
Hoe square-two prong

• 98207



8 000071 982078

Rastrello 5 denti / 5 teeth rake

• 98208



8 000071 982085





ACCIAIO VERNICIATO

Acciaio verniciato - manico plastica / Heavy duty - powder coating finish - plastic handle



Trapiantatore largo / Trowel

• 98998



Trapiantatore stretto / Transplantner

• 98999



Rastrello foglie / Leaf rake

• 99000



Rastrello 5 denti / 5 teeth rake

• 99001



Zappetta quadra-tridente
Hoe square-trident

• 99002



Zappetta cuore-tridente
Hoe heart-trident

• 99003



Foraterra / Dibble

• 99004





Badili forgiati		
Manico cm 140		
Forged shovels Handle 140 cm		
95600	A punta	8 000071 956000
95601	Quadra	8 000071 956017



Vanghe forgiate		
Manico cm 140		
Forged spades Handle 140 cm		
95605	A punta	8 000071 956055
95606	Quadra	8 000071 956062
95607	Per vivaista	8 000071 956079



Zappe forgiate		
Manico cm 135		
Forged hoes Handle 135 cm		
95611	Solita a cuore (gr 800)	8 000071 956116
95612	Solita quadra (gr 900)	8 000071 956123



Zappette forgiate		
Manico cm 135		
Forged hoes Handle 140 cm		
95614	Cuore bidente	8 000071 956147
95615	Quadra bidente	8 000071 956154
Zappette forgiate		
Manico cm 110		
Forged hoes Handle 110 cm		
95616	Cuore bidente	8 000071 956161
95617	Quadra bidente	8 000071 956178





attrezzi forgiati forged tools



Vanghe forgiate		Forged spades
Acciaio laminato		Rolled Steel
51611	A punta	
51658	Quadra	



Zappa forgiata		Forged hoe
17x17 cm		17 x 17 cm
51246	Cuore	



Zappette forgiate		Forged hoes
Ø foro 29-31 mm		Ø hole 29-31 mm
• 81287	Cuore / Bicorna	
• 81288	Quadra / Bicorna	

attrezzi manicati garden tools with handles



Badiletto auto		Mini shovel for car
Manico cm 60		Handle 60 cm
95604	Manico a D	



Vanga a punta
Manico cm 120

Point spade
Handle 120 cm

95608

Acciaio verniciato



Badile
Manico cm 130

Shovel
Handle 130 cm

• 83703



Vanga
Manico cm 130

Spade
Handle 130 cm

• 83711



linea MIGNON

Badiletto
Manico cm 110

Small shovel
Handle 110 cm

95628

Acciaio verniciato



Vanghetta a punta
Manico cm 110

Small point spade
Handle 110 cm

95629

Acciaio verniciato



Rastrello 10 denti
Manico cm 110

Rake 10 teeth
Handle 110 cm

95630

Acciaio verniciato





attrezzi manicati garden tools with handles



papillon

Zappini

Acciaio verniciato
Manico cm 110

Little hoes

Painted steel
Handle 110 cm

95618

Cuore bicorna



8 000071 956185

95619

Quadra bicorna



8 000071 956192



papillon

Zappe

Manico cm 130

Little hoes

Handle 110 cm

• 83709

Cuore bicorna



8 000071 837095

• 83708

Quadra bicorna



8 000071 837088

forche forks



papillon

Forca per vangare

Acciaio forgiato
Manico cm 140

Digging Fork

Forged steel
Handle 140 cm

95621

4 denti quadri



8 000071 956215



papillon

Forca per vangare / Digging Fork

80792

Denti triangolo



8 000071 807920

83636

Denti triangolo con manico



8 000071 836364

82046

Denti quadri



8 000071 820462



papillon

Forca

Acciaio forgiato
Manico cm 140

Fork

Forged steel
Handle 140 cm

95620

4 denti tondi



8 000071 956208



Forca per fieno e letame Fork for hay and manure		
Esecuzione 1/2 blu		
80785	3 denti	 8 000071 807852
50787	3 denti con manico	 8 000071 507875
80787	4 denti	 8 000071 807876
50788	4 denti con manico	 8 000071 507882
81746	5 denti	 8 000071 817462
80789	5 denti con manico	 8 000071 807890

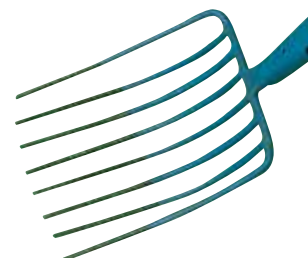
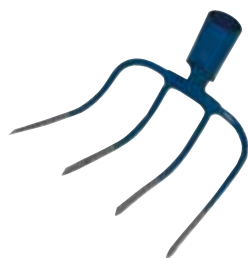
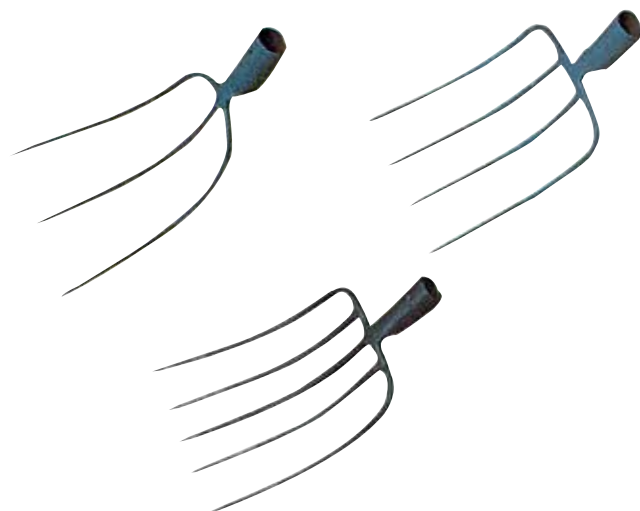

Forca denti piegati Fork with bent prongs		
Esecuzione 1/2 blu		
81748	4 denti / prongs	 8 000071 817486

Forca per ghiaia / Fork for gravel		
80795	8 denti / prongs	 8 000071 807951
80796	9 denti / prongs	 8 000071 807968



Sarchiatore ad arco con rastrello Arc weeder with rack		
Manico cm 150 Handle 150 cm		
95623	Acciaio zincato	 8 000071 956239





rastrelli rakes



Rastrello "tappeto erboso"

Acciaio zincato
Manico cm 180

Rake
Galvanized steel
Handle 180 cm

95624

34 denti

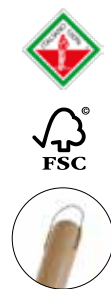

Rastrello plastica

Manico cm 180

Plastic rake
Handle 180 cm

95625

22 denti curvi



Rastrello "tirante"

Acciaio zincato
Manico cm 150

Rake
Galvanized steel
Handle 180 cm

95626

14 denti



Rastrelli

Con manico cm 130

Rakes

With handle 130 cm

• 83704

10 denti / teeth



• 83705

12 denti / teeth



• 83706

14 denti / teeth



• 83707

16 denti / teeth



Rastrelloni acciaio

tipo da sabbia e tappeti erbosi

Lawn and sand rakes

• 50749

34 denti / teeth





Rastrelloni alluminio / Aluminium rakes

50745	20 denti / teeth	8 000071 507455
51728	22 denti / teeth	8 000071 517287

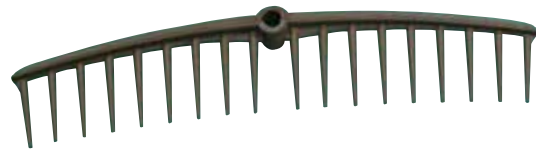

Rastrello plastica / Plastic rake

50764		8 000071 507646
--------------	--	-----------------



Rastrelli acciaio / Steel rakes
tipo pesante / heavy type

• 50757	10 denti / teeth	8 000071 507578
• 50758	12 denti / teeth	8 000071 507585
• 50759	14 denti / teeth	8 000071 507592
• 50760	16 denti / teeth	8 000071 507608
• 50761	18 denti / teeth	8 000071 507615



Rastrello arieggiatore / Lawngroom rake
In acciaio con denti ritorti / Steel made with twisted teeth

• 81286	14 denti / teeth	8 000071 812863
----------------	------------------	-----------------



Rastrello arieggiatore / Lawngroom rake
Struttura in acciaio verniciato / Painted steel body
Denti zincati / Galvanized steel teeth

• 86810	32 denti / teeth	8 000071 868105
----------------	------------------	-----------------



scope da giardino brooms and rakes



Rastrello scopa regolabile

In acciaio zincato
Manico 150 cm

Iron adjustable leaf rake
Galvanized steel
Handle 150 cm

95627



Scopa registrabile a leva

Con manico
Tutta in acciaio zincato

Adjustable Lawn Rake
With handle
Galvanized steel head

• 81492



Scopa registrabile

In acciaio zincato

Adjustable Lawn Rake
Galvanized steel

• 98200

Attacco conico



• 98201

Attacco a morsetto



Scopa fissa per foglie

In acciaio verniciato
Denti piatti

Leaf Rake
Painted steel
Flat teeth

• 81448



Scopa in plastica

Con manico

Plastic broom
With handle

50742





Scopa in bamboo
Con manico

Bamboo broom
With handle

50743



Scopa in Erica
Senza manico

Heather broom
Without handle

50232



Rastrelliera in polipropilene

22 posti per attrezzi da giardino a manico lungo
Dimensione 44 x 31 x 42 cm

Polypropylene garden tool rack
22 compartments for storing long handle tools
Dimension 44 x 31 x 42 cm

• 95480





Manici in legno / Turned wooden handle			
A	Manico tornito per rastrelli / Wooden handle for rakes		
	50766	150 cm	
	50767	180 cm	
B	Manico tornito tondo per zappe / Wooden handle for hoes		
	50770	Ø 30 mm	
	50728	Ø 40 mm	
B	Manico tornito tondo per zappini / Wooden handle for hoes		
	50786		
C	Manico tornito ovale per zappe / Wooden oval handle for hoes		
	50771		
D	Manico tornito per badili (in castagno) / Wooden handle for shovels		
	50229		
D	Manico tornito per badili (in faggio) / Wooden handle for shovels		
	50784		
D	Manico tornito per badili / Wooden handle for shovels		
	50231		
E	Manico tornito per vanghe / Wooden handle for spades		
	50785		
F	Manico sagomato per accette / Wooden handle for hatchets		
	50768		
G	Manico sagomato per scuri / Wooden handle for axes		
	50769		
H	Manico sagomato per picconi / Wooden handle for picks		
	50230		
I	Manici in metallo / Steel handle		
	Manico allungabile in metallo tubolare / Telescopic tubular handle		
	52120		



Falciole "seghezzo cantoniere" Small sickle
Acciaio forgiato Forged steel
Manico lungo Long handle

95632



Falciole "messorella erba" Small sickle
Acciaio forgiato Forged steel
Manico corto Short handle

95633



Falciole per rovi Small sickle
Modello pesante / Acciaio forgiato Heavy duty / Forged steel
Manico lungo Long handle

95634



Falciole per rovi Small sickle
Modello pesante / Acciaio forgiato Heavy duty / Forged steel
Manico corto con rampino Short handle with hook

95635



Falciole - mod. TEMPO / Sickles

80765 N. 0

80766 N. 1

80767 N. 2

Seghezzi / Tooth sickles

80759 N. 2

80760 N. 3

Falciole "BACKA" "BACKA" sickles
Manico lungo Long handle

80770



falci e roncole sickles and billhook



papillon

Manaresso

Acciaio forgiato / molato
Manico cuoio

"Manaresso" Billhook
Forged steel
Leather handle

95647



papillon

Roncola macete

Acciaio forgiato / Lama lucida
Manico legno
Con fodero

Billhook machete
Forged steel / Shiny blade
Leather handle
With cover

95649



papillon

Roncola "tipo classico"

Acciaio forgiato / molato
Manico cuoio

Billhook
Forged steel
Leather handle

95648



papillon

Pennato

Acciaio forgiato / molato
Manico cuoio
Con fodero

Twin edge billhook
Forged steel
Leather handle
With cover

95650



papillon

Roncolino

Acciaio forgiato / molato
Manico legno rosso

Small Billhook
Forged steel
Red Wood handle

95654





Roncola a mezzaluna

Acciaio forgiato / molato
Manico tubolare

Billhook Half-moon shape
Forged steel
Tubular handle

95651



8 000071 956512



Roncola a pertica / Long arm slasher

80775

N. 0

Ronchina per orto / Billhook

80777

22 cm



Gancio porta roncola

Acciaio zincato

Hook for billhook
Forged steel

95653



8 000071 956536



Falce per fieno

Acciaio forgiato
Lunghezza 65 cm

Sickle for hay
Forged steel
Length 65 cm

95631



8 000071 956314



Manico per falce

Tubolare in acciaio
Ø 3,5 cm

Handle for sickle
Steel tubular frame
Length 65 cm

95639



8 000071 956390





falci sickles



Falcioni *DUE OTTOMANI*

Modello senza barba, punta chiodo - Strettissime

80701	lunghezza 55 cm
80702	lunghezza 60 cm
80703	lunghezza 65 cm



Manico per falci

Tubolare in acciaio

Sickles handle

Steel tubular frame

50790



Cote smeriglio / Whetstone

95637



Porta cote in plastica / Whetstone holder

95638



Anello ferma falce

Acciaio

Ring for sickle's handle

Iron

95636

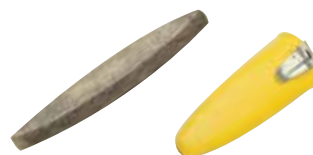

Accessori per falci / Sickles accessories

• 80698 Pietre coti smeriglio / Emery stones

50795 Porta coti in plastica / Plastic support

portaforbici shear holder



Portaforbici in nylon / Nylon shear holder

• 93776



Portaforbici in pelle / Leather shear holder

• 93778





mod. CLASSIC LIGHT

Leggera e maneggevole
Taglio passante
Lama acciaio SK5
Capacità di taglio su legno verde 18 mm
Manici alluminio
Lunghezza 210 mm

Lightweight easy to use
By-pass cut
SK5 steel blade
Cutting capacity 18 mm
Aluminium handles
Length 210 mm

• 96798



easy/cut



mod. CLASSIC

Taglio passante
Lama acciaio SK5
Capacità di taglio su legno verde 20 mm
Manici alluminio
Due posizioni di taglio
Lunghezza 215 mm

By-pass cut
SK5 steel blade
Cutting capacity 20 mm
Aluminium handles
Two position lock
Length 215 mm

• 93886



mod. ERGONOMIC

Testa di taglio inclinata
Taglio passante
Lama acciaio SK5
Capacità di taglio su legno verde 20 mm
Manici alluminio
Due posizioni di taglio
Lunghezza 215 mm

Tilted cutting head
By-pass cut
SK5 steel blade
Cutting capacity 20 mm
Aluminium handles
Two position lock
Length 215 mm

• 93887



mod. PREMIUM

Taglio passante
Corpo in alluminio
Sbloccaggio lama mediante pressione sull'impugnatura
Lama acciaio Easycut
Capacità di taglio su legno verde 20 mm
Impugnatura antiscivolo
Con ammortizzatore
Lunghezza 205 mm

By-pass cut
Aluminium body
Unclamping the lock by handles pressure
Easycut steel blade
Cutting capacity 20 mm
Antislip PVC grip handles
With damper
Length 205 mm

• 92925



easy/cut



forbici per potatura professionali professional pruning shears

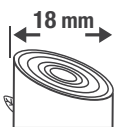

KANZAWA mod. KS-4

Taglio passante
Lama acciaio temprato cromato
Capacità di taglio su legno verde 18 mm
Con ammortizzatore e tagliafilì
Lunghezza 220 mm

By-pass cut
Chrome-tempered blade
Cutting capacity 18 mm
With damper and wire cutter
Length 220 mm

• 87399



Lama acciaio / Blade

Molla universale / Spring

• 87600



• 87602

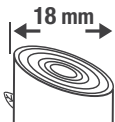

mod. STRONG

Taglio passante
Corpo acciaio forgiato
Capacità di taglio su legno verde 18 mm
Impugnatura in spugna antiscivolo
Lunghezza 205 mm

By-pass cut
Drop forged constructions
Cutting capacity 18 mm
Foam coated non-slip handles
Length 205 mm

• 89442



mod. PROCUT

Taglio passante
Acciaio al carbonio forgiato a caldo
fermo di chiusura in cuoio
Capacità di taglio su legno verde 20 mm
Lunghezza 200 mm

By-pass cut
Drop forged high carbon steel
Leather closure
Cutting capacity 20 mm
Length 200 mm

• 98236

180 mm



• 55619

200 mm

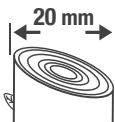

mod. CRICUT

Taglio a battuta a cricco - Ratchet system
Lama Easycut
Capacità di taglio su legno verde 22 mm
Impugnatura inferiore avvolgente
Lunghezza 210 mm
Peso 260 gr

Anvil ratchet - Ratchet system
Easycut coated blade
Cutting capacity 22 mm
Looping lower handle
Length 210 mm
Weight 260 gr

• 87773



Set lame Easycut / Easycut blades set

• 88330

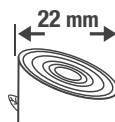

easy/cut



mod. DUALCUT

Doppio taglio	Double edge
Acciaio al cromo-vanadio forgiato a caldo	Drop forged chrome-vanadium steel
Capacità di taglio 25 mm	Cutting capacity 25 mm
Manici plastificati antiscivolo	Anti-slip plastic handles
Fermo di sicurezza in metallo	Metal safety latch
Lunghezza 200 mm	Length 200 mm

• 55618

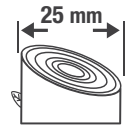

mod. BABY

Manici plastificati	Plastic handles
Lunghezza 165 mm	Length 165 mm

• 81695



mod. BASIC

Taglio passante	By-pass cut
Alluminio pressofuso	Aluminium body
Lama acciaio carbonio	Carbon steel blade
Lunghezza 200 mm	Length 200 mm

• 93885



Cogliuva	Grape shear
Manici plastificati	Plastic handles
Lunghezza 175 mm	Length 175 mm

• 81694



Cogliuva	Grape shear
Lame in acciaio speciale finitura brunita	Special steel blades Burnish finish
Chiusura a nastro	Belt closure
Lunghezza 192 mm	Length 192 mm

• 88332





forbici per erba grass shear



Forbice per erba professionale

Lame acciaio inossidabile
Lame regolabili su 6 posizioni
Manici gomma antiscivolo

Professional grass shear
Inox steel blade
6 positions
Rubber antigrip handles

• 87286



easy/cut



Lama EasyCut
Lame regolabili 360°
Manici ammortizzati

Easycut blade
Free section
Handles with damper

• 87285



cesoie - raccoglifrutta tree pruner - fruit picker



Cesoia raccoglifrutta

Manico prolungato in alluminio girevole -
Lunghezza 2 metri

Fruit picker
Swivel long arm aluminium tube
Length 2 m

• 80696



Raccoglifrutta

Senza manico

Fruit picker
Without handle

• 80693





Cesoia per potatura

2 impugnature di taglio
Lama Easycut / Lama acciaio SK-5
Manico tubolare in alluminio
Taglio inclinato a 180° - 6 regolazioni
Capacità di taglio su legno verde 20 mm
Blocco di sicurezza
Lunghezza 2 metri

Tree pruner
2 Cutting grip for pruning
Easycut blade / Steel blade SK-5
Long arm aluminium tube
Cutting tilted to 180° - 6 settings
Cutting capacity on green material 20 mm
Safety lock
Length 2 m

• 98769



Cesoia per potatura

Lama Easycut / Lama acciaio SK-5
Manico tubolare in alluminio
Capacità di taglio su legno verde 15 mm
Lunghezza 2 metri

Tree pruner
Easycut blade / Steel blade SK-5
Long arm aluminium tube
Cutting capacity on green material 15 mm
Length 2 m

• 93906

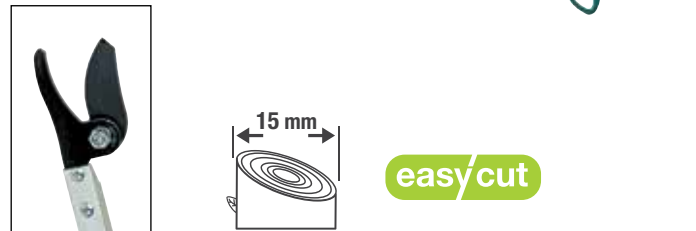

Cesoia potatura - raccoglifrutta

Lama Easycut / Lama acciaio SK-5
Manico in alluminio telescopico a 6 posizioni da 190 cm a 309 cm
Capacità di taglio su legno verde 12 mm
Testa regolabile in 3 posizioni
Con gancio

Tree pruner - Fruit picker
Easycut blade / Steel blade SK-5
Telescopic aluminium handle
6 sections: 190-309 cm
Cutting capacity on green material 12 mm
Adjustable head 3 positions
With hook

• 97755

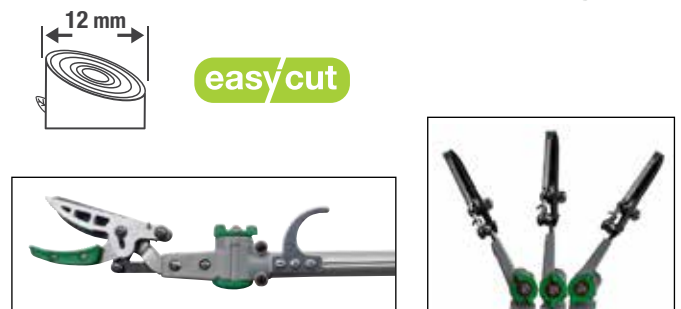



tagliarami telescopici telescopic loppers



Taglio a battuta a cricco
Lama Easycut in acciaio SK5
Manici telescopici ovali in alluminio con pulsante di blocco
Impugnatura in bicomponente ergonomica
Lunghezza 700÷1060 mm

Hook anvil ratchet
Easycut steel SK5 blade
Telescopic aluminium handles with button stop
Ergonomic bicomponent handle
Length 700÷1060 mm

• 90979

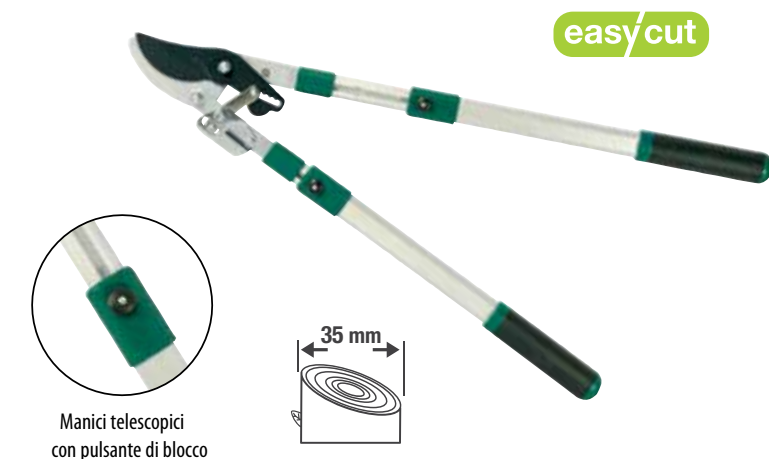

Taglio passante a cricco
Lama Easycut
Manici telescopici ovali in alluminio con pulsante di blocco
Impugnatura in bicomponente ergonomica
Lunghezza 700÷1015 mm

By-pass ratchet
Easycut blade
Telescopic aluminium handles with lever stop
Ergonomic bicomponent handle
Length 700÷1015 mm

• 89597

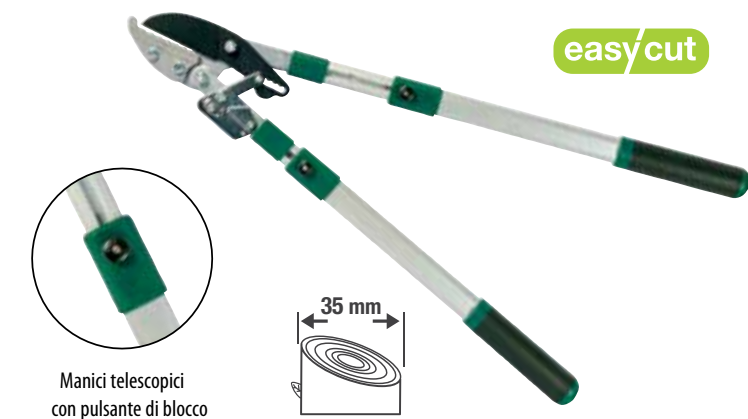

Taglio a battuta a cricco
Lama Easycut
Manici telescopici ovali in alluminio con pulsante di blocco
Impugnatura in bicomponente ergonomica
Lunghezza 700÷1015 mm

Hook anvil ratchet
Easycut blade
Telescopic aluminium handles with lever stop
Ergonomic bicomponent handle
Length 700÷1015 mm

• 89596





ENERGY SAVING

Lama Easycut
Taglio passante a cricco
Manici alluminio
Impugnatura in bicomponente ergonomica
Lunghezza 760 mm

ENERGY SAVING

Easycut blade
By-pass ratchet
Aluminium handles
Ergonomic bicomponent handle
Length 760 mm

• 90147

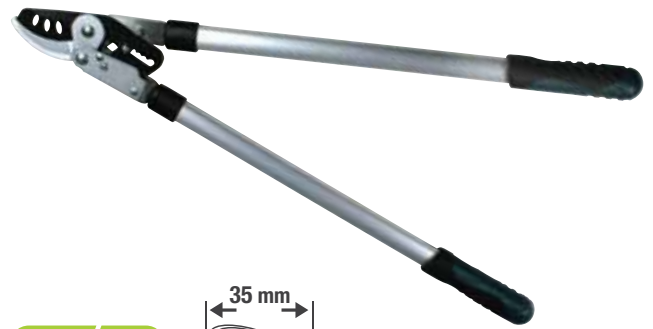

easy/cut

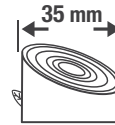

ENERGY SAVING

Lama Easycut
Taglio battuta a cricco
Manici alluminio
Impugnatura in bicomponente ergonomica
Lunghezza 760 mm

ENERGY SAVING

Easycut blade
Anvil ratchet
Aluminium handles
Ergonomic bicomponent handle
Length 760 mm

• 90148

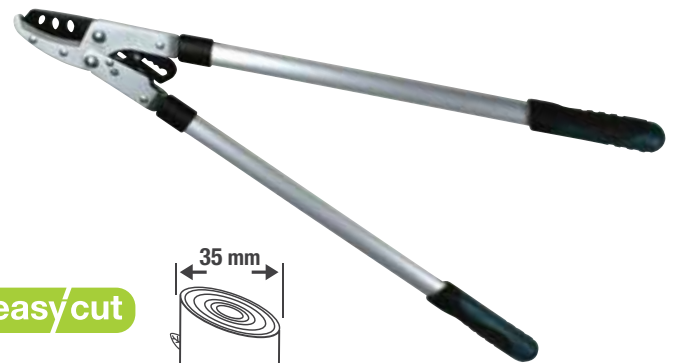

easy/cut

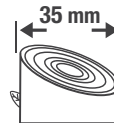

Lama Easycut

Taglio passante demoltiplicato
Manici tubolari acciaio
Lunghezza 750 mm

Easycut blade

By-pass cut
Tubular steel handles
Length 750 mm

• 83405

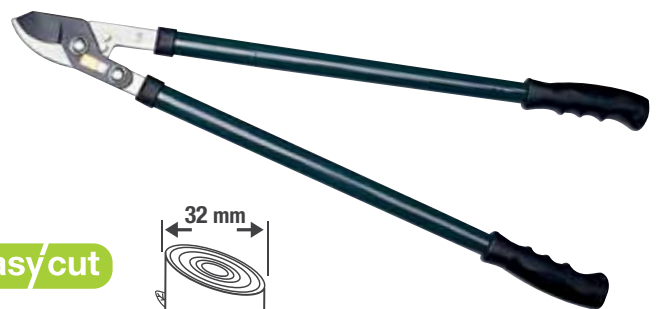

easy/cut

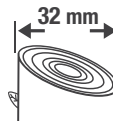

Lama Easycut

Taglio a battuta demoltiplicato
Manici tubolari acciaio
Lunghezza 750 mm

Easycut blade

Anvil lever
Tubular steel handles
Length 750 mm

• 83406

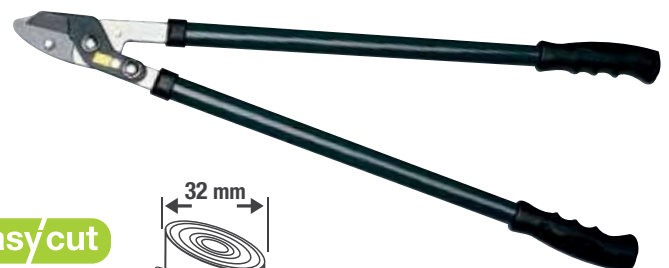

easy/cut





forbici per siepe hedges shears



easy/cut

Manici telescopici
con pulsante di blocco

 papillon

mod. TELESCOPICO

Lame ondulate Easycut
Lunghezza lame 230 mm
Manici ovali telescopici in alluminio
con pulsante di blocco
Impugnatura in bicomponente
ergonomica
Lunghezza 705÷860 mm

Easycut wavy blades
Blades length 230 mm
Telescopic aluminium handles with
lever stop
Ergonomic bicomponent handle
Length 705÷860 mm

• 89595



easy/cut

 papillon

mod. FISSO

Lame ondulate Easycut
Lunghezza lame 225 mm
Manici tubolari in alluminio con
ammortizzatore
Impugnatura in bicomponente
ergonomica

Easycut wavy blades
Blade length 225 mm
Tubular aluminium handles with
damper
Ergonomic bicomponent handle

• 86167



 papillon

Lunghezza lame 210 mm
Con ammortizzatore
Manici in legno

Blade length 210 mm
With damper
Wooden handles

• 85995





Manico pieghevole	Folding saw
Con pulsante di bloccaggio lama	With push button locking blade
Lama acciaio SK5 - Cromata	Steel blade SK5 - Chrome
Dentatura speciale rettificata su 3 angoli, affilata, temprata	Special grind teeth, sharpened and tempered
Impugnatura bicomponente ergonomica e antiscivolo	Bicomponent ergonomic handle and no slip grip

• 80692 lama / blade 170 mm 8 000071 806923

• 85947 lama / blade 220 mm 8 000071 859479



Manico pieghevole	Folding saw
Con pulsante di bloccaggio lama	With push button locking blade
Lama curva acciaio SK5	Curve steel blade SK5
Tripla affilatura e denti temprati	Triple edge and impulse hardened teeth
Impugnatura bicomponente ergonomica e antiscivolo	TPR handle ergonomic and no slip grip

• 94965 lama / blade 180 mm 8 000071 949651



Lama curva in acciaio SK5 - Cromata	Curve steel blade SK5 - Chrome
Dentatura speciale rettificata su 3 angoli, affilata, temprata	Special grind teeth, sharpened and tempered
Manico tubolare acciaio ad ombrello	Steel tubular umbrella handle

• 88361 lama / blade 350 mm 8 000071 883610



Lama dritta acciaio SK5 - Cromata	Steel blade SK5 - Chrome
Dentatura speciale rettificata su 3 angoli, affilata, temprata	Special grind teeth, sharpened and tempered
Impugnatura bicomponente ergonomica e antiscivolo	Bicomponent ergonomic handle and no slip grip
Con fodero	With scabbard

• 85698 lama / blade 250 mm 8 000071 856980

• 84527 lama / blade 300 mm 8 000071 845274





segacci potatura lama fissa pruning saws



Lama dritta acciaio SK5
 Triplice affilatura e denti temprati
 Impugnatura bicomponente ergonomica e antiscivolo
 Con fodero

Steel blade SK5
 Triple edge and impulse hardened teeth
 TPR handle ergonomic and no slip grip
 With scabbard

• 94966

lama / blade 300 mm



8 000071 949668



Lama curva acciaio SK5
 Triplice affilatura e denti temprati
 Impugnatura bicomponente ergonomica e antiscivolo
 Con fodero

Steel blade SK5
 Triple edge and impulse hardened teeth
 TPR handle ergonomic and no slip grip
 With scabbard

• 94967

lama / blade 330 mm



8 000071 949675



Lama curva in acciaio SK5 - Cromata
 Dentatura speciale rettificata su 3 angoli, affilata, temprata
 Impugnatura bicomponente ergonomica e antiscivolo

Curve steel blade SK5 - Chrome
 Special grind teeth, sharpened and tempered
 Bicomponent ergonomic handle and no slip grip

• 88337

lama / blade 350 mm



8 000071 883375



Lama curva in acciaio SK5 - Cromata
 Dentatura speciale rettificata su 3 angoli, affilata, temprata
 Impugnatura tubolare adatta anche per prolunga a pertica
 Con dispositivo tagliente scortecciatore

Curve steel blade SK5 - Chrome
 Special grind teeth, sharpened and tempered
 Steel tubular handle suitable for perch extension
 With peeling knife

• 88338

lama / blade 400 mm



8 000071 883382



tree pruners **svettatoi**



Taglio semplice - metallo verniciato
Con lama temprata

Single cut - painted steel
Hardened steel blade

• 83657



Svettatoio telescopico
Manico alluminio estensibile
Con lama temprata
Lunghezza max 2,50 metri

Telescopic tree pruner
Tubular aluminium handle
Hardened steel blade
Length max 2,50 m

• 80697



bow saws **segoncini**



Attacco portalama girevole
Telaio tubolare con leva di tensione
Impugnatura paracolpi
Con 2 lame legno/metalli 300 mm

Revolving bow saw
Tubular frame with tension lever
Buffer handle
With 2 blade wood/metal 300 mm

91643



Attacco portalama girevole
Telaio tubolare con leva di tensione
Con lama 533 mm

Revolving bow saw
Tubular frame with tension lever
With blade 533 mm

91641







segoncini bow saws



Attacco portalama fisso Revolving bow saw
Telaio tubolare con leva di tensione Tubular frame with tension lever

91644 610 mm  8 000071 916448

91646 812 mm  8 000071 916462

91647 914 mm  8 000071 916479

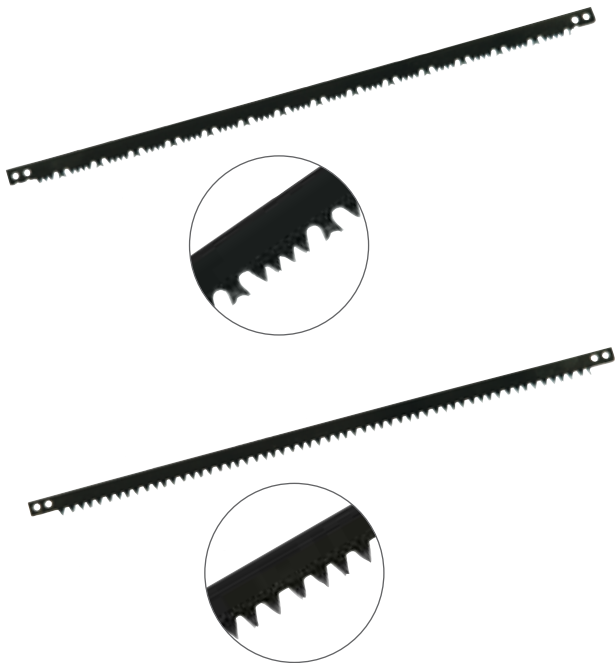



Lama dentatura castello Serration castle blade
Per taglio legna verde Cutting green wood

91675 300 mm  8 000071 916752

91648 533 mm  8 000071 916486

91649 610 mm  8 000071 916493

91650 762 mm  8 000071 916509

91651 812 mm  8 000071 916516

91652 914 mm  8 000071 916523

Lama dentatura triangolo Triangular castle blade
Per taglio legna secca Cutting dry wood

91653 533 mm  8 000071 916530

piccozzini hatchets



Piccozzino Hatchet
Acciaio forgiato Forged steel
Manico legno verniciato Wooden handle

95643 400 gr / 400 mm  8 000071 956437



Piccozzini Hatchets
Acciaio temprato Forged steel
Manico legno sagomato e verniciato Wooden handle

• 80189 600 gr / 360 mm  8 000071 801898



hatchets **piccozzini**



MAURER

Piccozzini

Acciaio temprato
Manico fibra vetro

Hatchets
Forged steel
Fibreglass handle

• **86618**

600 gr / 360 mm



• **86619**

800 gr / 380 mm



MAURER

Piccozzino

Corpo acciaio forgiato e verniciato
Manico ergonomico antiscivolo in
fibra di vetro ricoperto in PP+TPR

Hatchets
Forged steel body
Ergonomic antislip handle fiberglass
covered on PP+TPR

• **94280**

600 gr / 350 mm



axes **scuri**

papillon

Scure "Yankee"

Acciaio forgiato molato e verniciato
Manico legno sagomato e verniciato

Axe "Yankee"
Forged steel
Wooden handle

95645

1900 gr / 900 mm



MAURER

Scure

Acciaio temprato
Manico legno verniciato

Axes
Hardened steel
Wooden handle

• **80187**

1500 gr / 800 mm



MAURER

Scure

Acciaio temprato
Manico fibra vetro

Axes
Hardened steel
Fibreglass handle

• **86622**

1500 gr / 800 mm





mazze spaccalegna splitting axes



Mazza spaccalegna

Acciaio forgiato molato e verniciato
Collare di sicurezza
Manico legno verniciato

Splitting axe
Forged steel
Safety collar
Wooden handle

95644

2500 gr / 900 mm



8 000071 956444



Mazza spaccalegna

Corpo acciaio forgiato e verniciato
Manico ergonomico antiscivolo in fibra di vetro ricoperto in PP+TPR
Collare di sicurezza

Hatchets
Forged steel body
Ergonomic antislip handle fiberglass covered on PP+TPR
Safety collar

• 94277

2720 gr / 900 mm



8 000071 942775

• 94278

3630 gr / 900 mm



8 000071 942782



Mazza spaccalegna

Con arpione
Corpo acciaio forgiato e verniciato
Manico ergonomico antiscivolo in fibra di vetro ricoperto in PP+TPR
Collare di sicurezza

Hatchets
With harpoon
Forged steel body
Ergonomic antislip handle fiberglass covered on PP+TPR
Safety collar

• 94279

3000 gr / 900 mm



8 000071 942799

picconi pickaxes



Zappa scure

Acciaio forgiato / molato
Occhio ovale
Collare di sicurezza
Manico legno verniciato

Pickaxe Garden style
Forged steel
Oval connection
Safety collar
Wooden handle

95642

900 mm



8 000071 956420



Coltello innesto pieghevole

Lama acciaio inox
Lama a filo diritto
Manico legno
Lunghezza totale 17,6 cm

Grafting budding knife foldable
Stainless steel blade
Wooden handle
Total length 17,6 cm

• 93741



Coltello "Boscaiolo"

Con spazzolino
Lama acciaio inox
Lama curva
Manico legno
Lunghezza totale 18 cm

Folding pocket knife
With brush
Stainless steel blade
With nail groove
Wooden handle
Total length 18 cm

• 94772



Coltello serramanico

Lama acciaio inox
Con spelafilo e clip cintura
Impugnatura in alluminio
Fodero in nylon
Lunghezza totale 20 cm

Switchblade knife
Stainless steel blade
With wire stripper and belt clip
Aluminum handle
Nylon sheath
Total length 20 cm

• 93742



Coltello serramanico

Lama acciaio inox
Con clip cintura
Impugnatura in alluminio
Fodero in nylon
Lunghezza totale 19,5 cm

Switchblade knife
Stainless steel blade
With belt clip
Aluminum handle
Nylon sheath
Total length 19,5 cm

• 93744



Coltello serramanico

Lama acciaio inox
Con clip cintura
Impugnatura in alluminio
Fodero in nylon
Lunghezza totale 18,5 cm

Switchblade knife
Stainless steel blade
With belt clip
Aluminum handle
Nylon sheath
Total length 18,5 cm

• 93745





casette box da giardino garden sheds

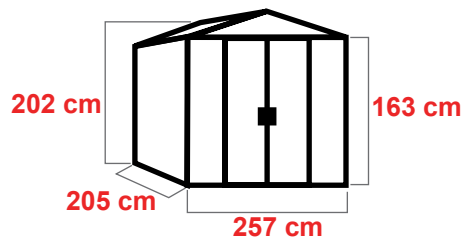

MAURER

Casetta box da giardino

Tetto due spioventi
Struttura in lamiera zincata e verniciata
Porte scorrevoli su guide
Completa di struttura in acciaio per base pavimento
Con bocchette di ventilazione
Colore verde
Dim. 205 x 257 x 202 cm

Box for garden shed
Apex roof
Frame galvanized painted plate
Sliding doors on runners
Steel structure for base floor included
With ventilation
Green colour
Dim. 205 x 257 x 202 cm

• 95534



8 000071 955348

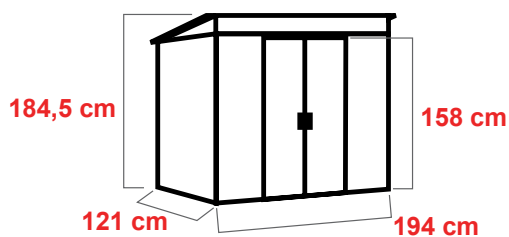

MAURER

Casetta box da giardino

Tetto uno spiovente
Struttura in lamiera zincata e verniciata
Porte scorrevoli su guide
Completa di struttura in acciaio per base pavimento
Con bocchette di ventilazione
Colore verde
Dim. 121 x 194 x 184,5 cm

Box for garden shed
Pent roof
Frame galvanized painted plate
Sliding doors on runners
Steel structure for base floor included
With ventilation
Green colour
Dim. 121 x 194 x 184,5 cm

• 95535



8 000071 955355



IRRIGAZIONE, POMPE E IDROPULTRICI



CATALOGO
GIARDINAGGIO
2017



idropulitrici high pressure washer



ad acqua fredda / cold water

YAMATO**mod. AVENS****Potenza 1500 watt**

Power 1500 watt

Auto Stop Function - Sistema di attivazione o arresto totale azionando la leva della pistola

Auto Stop Function - Remote control for total shutdown activated by releasing the trigger

Tubo ad alta pressione con attacco rapido per pistola e macchina

High pressure tube with quick connector on gun and machine

Ugelli ad innesto e sgancio rapido

Nozzles with quick-release attachment

Lancia con ugello getto regolabile

Gun with adjustable spray nozzle

Diffusore detergente con barattolo

Foam sprayer with detergent control

Pressione 105 bar max

Max pressure 105 bar

Portata 408 l/h max

Max flow 408 l/h

3 metri di tubo alta pressione

3 m high pressure tube

• 96581



ad acqua fredda / cold water

YAMATO**mod. LIRIS****Potenza 1900 watt**

Power 1900 watt

Auto Stop Function - Sistema di attivazione o arresto totale azionando la leva della pistola

Auto Stop Function - Remote control for total shutdown activated by releasing the trigger

Tubo ad alta pressione con attacco rapido per pistola e macchina

High pressure tube with quick connector on gun and machine

Ugelli ad innesto e sgancio rapido

Nozzles with quick-release attachment

Lancia con ugello getto regolabile

Gun with adjustable spray nozzle

Diffusore detergente con barattolo

Foam sprayer with detergent control

Pressione 135 bar max

Max pressure 135 bar

Portata 420 l/h max

Max flow 420 l/h

5 metri di tubo alta pressione

5 m high pressure tube

• 96582





ad acqua fredda / cold water

YAMATO

mod. NURE

Potenza 2200 watt

Power 2200 watt

Auto Stop Function - Sistema di attivazione o arresto totale azionando la leva della pistola

Auto Stop Function - Remote control for total shutdown activated by releasing the trigger

Tubo ad alta pressione con attacco rapido per pistola e macchina

High pressure tube with quick connector on gun and machine

Ugelli ad innesto e sgancio rapido

Nozzles with quick-release attachment

Lancia con ugello getto regolabile

Gun with adjustable spray nozzle

Serbatoio detergente integrato

Built-in detergent tank

Include ugello schiumogeno

Detergent nozzle

Avvolgitubo integrato

Integrated hose reel

Pressione 165 bar max

Max pressure 165 bar

Portata 480 l/h max

Max flow 480 l/h

8 metri di tubo alta pressione

8 m high pressure tube

• 96583



CE



Serbatoio detergente integrato
Built-in detergent tank



accessories pressure washers **accessori idropultrici**



YAMATO

Ugello turbo / Rotating nozzle

• 96584



YAMATO

Ugello angolare / Angle nozzle

• 96585



YAMATO

Spazzola lavaggio / Brush

• 96586



Con ugello e regolatore
With nozzle and detergent control

YAMATO

Bottiglia detergente / Soap bottle

• 96592





accessori idropultrici accessories pressure washers



YAMATO

Spazzola rotante lavapavimenti / Patio cleaner

• 96587



YAMATO

Pistola e lancia / Gun and lance

• 96591



YAMATO

Tubo alta pressione / High pressure tube

• 96588

3 metri



• 96589

5 metri



• 96590

8 metri



YAMATO

Kit spurgatubi - tubo 10m / Pipe cleaning hose

• 96593



YAMATO

Kit lancia sabbiante - tubo 5m / Sand blasting lance

• 96594





mod. NARWHAL

Pompa sommergibile multiuso per drenaggio, svuotamento, piccola irrigazione.
Adatta per pompare acque pulite contenenti particelle solide di diametro max 5 mm

Multi-purpose submersible pump for drainage, emptying, small irrigation.
Suitable to pump clear water containing particles with max diameter up to 5 mm

W _{att}	H _{max} m	P _{max} m	Q _{max} l/h	Ø max mm	Ø poll. mm	kg. ca.
200	5	5	4000	5	3/4" 1"	3,4

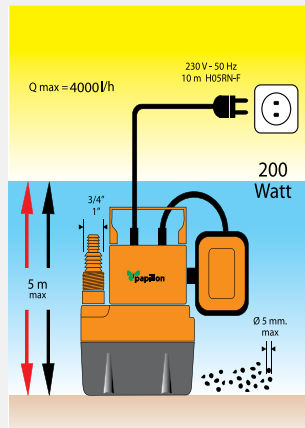

• 91850



mod. DOLPHIN

Pompa sommergibile multiuso per drenaggio, svuotamento, piccola irrigazione.
Adatta per pompare acque pulite contenenti particelle solide di diametro max 5 mm

Multi-purpose submersible pump for drainage, emptying, small irrigation.
Suitable to pump clear water containing particles with max diameter up to 5 mm

W _{att}	H _{max} m	P _{max} m	Q _{max} l/h	Ø max mm	Ø poll. mm	kg. ca.
400	8	5	7000	5	1" 1.1/4" 1.1/2"	4,5

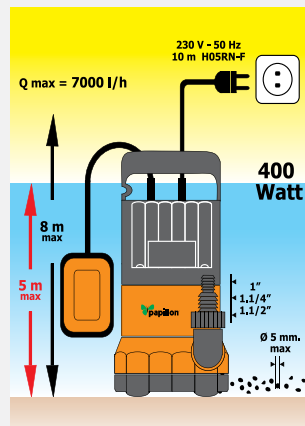

• 91851



mod. MORAY

Pompa sommergibile multiuso per drenaggio, svuotamento, travaso, piccola irrigazione.
Adatta per pompare acque sporche contenenti particelle solide di diametro max 30 mm

Multi-purpose submersible pump for drainage, emptying, pumping, small irrigation.
Suitable to pump dirty water containing particles with max diameter up to 30 mm

W _{att}	H _{max} m	P _{max} m	Q _{max} l/h	Ø max mm	Ø poll. mm	kg. ca.
400	5	5	7500	30	1" 1.1/4" 1.1/2"	4,6

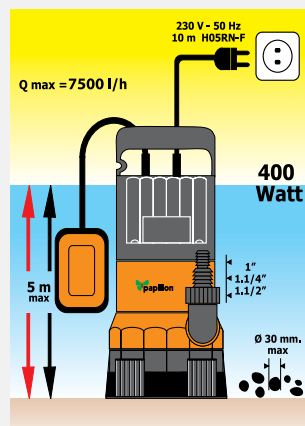

• 91852



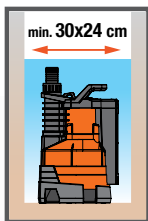

papillon

mod. LOBSTER

Pompa sommersibile multiuso per drenaggio, svuotamento, piccola irrigazione. Galleggiante integrato. Ideale per l'impiego in pozze di dimensioni ridotte (minimo 30 x 24 cm). Adatta per pompare acque pulite contenenti particelle solide di diametro max 5 mm.

Multi-purpose submersible pump for drainage, emptying, small irrigation. With integrated float switch. Suitable for small draining wells (min. 30x24 cm). Suitable to pump clear water containing particles with max diameter up to 5 mm.

W _{att}	H _{max} ↑ m	P _{max} ↓ m	Q _{max}	Ø max mm	Ø poll. "	kg. ca.
750	8,5	7	13000	5	1" 1.1/2"	3,4

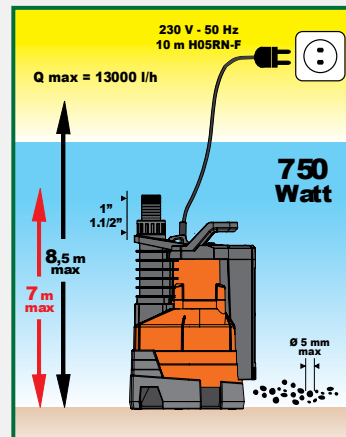

• 99091



papillon

mod. BREAM - inox

Elettropompa sommersibile 3 giranti. Adatta per pompare acqua chiara da pozzi, cisterne, serbatoi e stagni. Indicata per altre applicazioni che richiedono alta pressione. Corpo pompa in acciaio inox.

Submersible pump with 3 impellers. Suitable to pump clear water from wells, cisterns, tanks and ponds. Pump body in stainless steel.

W _{att}	H _{max} ↑ m	P _{max} ↓ m	Q _{max} l/h	Ø max mm	Ø poll. "	kg. ca.
800	30	5	5500	0,5	1"	7

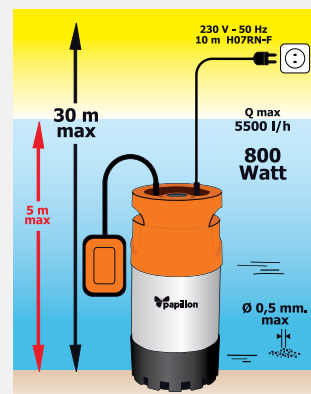

• 94737





mod. SHARK

Pompa sommersibile multiuso per drenaggio, svuotamento, travaso, piccola irrigazione. Adatta per pompare acque sporche contenenti particelle solide di diametro max 35 mm

Multi-purpose submersible pump for drainage, emptying, pumping, small irrigation. Suitable to pump dirty water containing particles with max diameter up to 30 mm

Watt	H max m	P max m	Q max l/h	Ø max mm	Ø poll. mm	kg. ca.
850	8	8	13500	35	1" 1.1/4" 1.1/2"	6,2

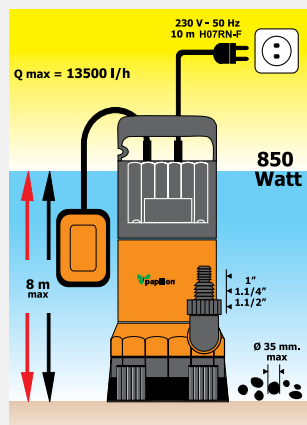

• 91853



mod. GROUPER - inox

Pompa sommersibile multiuso per drenaggio, svuotamento, travaso, piccola irrigazione. Adatta per pompare acque sporche contenenti particelle solide di diametro max 20 mm. Livello minimo di aspirazione 7 cm

Multi-purpose submersible pump for drainage, emptying, pumping, small irrigation. Suitable to pump dirty water containing particles with max diameter up to 20 mm. Low suction capability 7 cm

Watt	H max m	P max m	Q max l/h	Ø max mm	Ø poll. mm	kg. ca.
1100	8	5	18500	20	1" 1.1/4" 1.1/2"	6,0

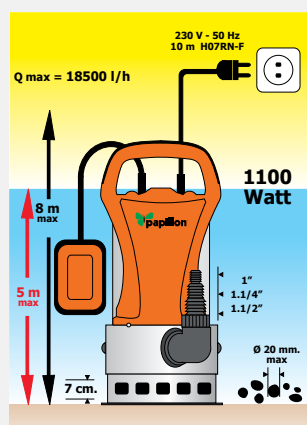

• 93254





elettropompe pumps



mod. ANGLER - inox

Elettropompa sommersibile adatta per pompare acque sporche contenenti particelle solide di diametro fino a 40 mm, ideale per svuotamento, drenaggio di cantine, pozzi e piscine. Corpo pompa in acciaio inox.

Submersible pump suitable for pumping dirty water containing suspended solids up to 40 mm diameter, ideal for drainage of cellars, wells and swimming pools. Pump body in stainless steel.

W _{att}	H _{max} ↑ m	P _{max} ↓ m	Q _{max} l/h	Ø max mm	Ø poll. mm	kg. ca.
1300	11,5	7	25000	40	1.3/4" 2" 2.1/4"	7,5

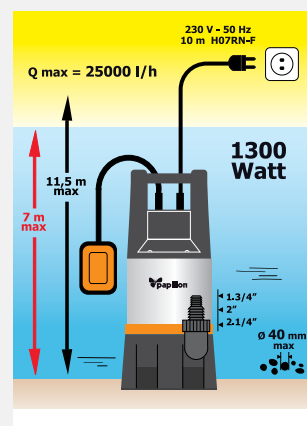

• 94738



Pompe autoadescanti per l'approvvigionamento idrico in giardino e casa.

Self-priming pump ideal for supplying water for gardening and domestic applications.

	W _{att}	H _{max} ↑ m	P _{max} ↓ m	Q _{max} l/h	Ø poll. mm	kg. ca.
RAY	600	35	8	3000	1"	6,7
TUNNY	800	40	8	3200	1"	7,0

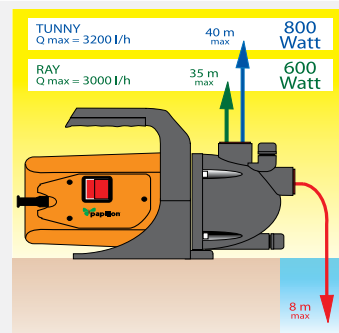

mod. TUNNY

• 91856



mod. RAY

• 91855



filtri filter



Filtro anticalcare per lavatrice
Cartuccia filtrante con sali polifosfati
Attacchi entrata 3/4"F - uscita 3/4"M

Protection filter for washing machine
Cartridge with polyphosphate crystals
Connections IN 3/4"F - OUT 3/4"M

• 95681





Contenitore per cartucce filtranti

Attacchi con filettatura in ottone da 1" F/F (entrata e uscita)

Testata e ghiera in polipropilene rinforzato

Vaso trasparente e guarnizione O-ring

Staffa per il fissaggio a parete

Chiave in polipropilene (solo per 10")

Pressione d'esercizio 8 bar (max)

Temperatura d'esercizio 45°C (max)

Filter housing. Height 5".

Connections 1" brass screw threads F/F (IN/OUT)

Head and ring nut reinforced polypropylene

Transparent bowl and O-ring seal

Wall mounting bracket

Wrench (only for 10").

Max working pressure 8 bar

Max working temperature 45°C

• 95671

Altezza / height 10"



• 95672

Altezza / height 5"



A) Cartuccia filtrante in rete lavabile / Washable net cartridge filter

• 95673

Altezza / height 10"



• 95674

Altezza / height 5"



B) Cartuccia filtrante in filo avvolto - PP / String wound filter cartridge

• 95675

Altezza / height 10"



• 95676

Altezza / height 5"



C) Cartuccia filtrante ai carboni attivi / Granular active carbon filter cartridge

• 95677

Altezza / height 10"



• 95678

Altezza / height 5"



D) Cartuccia filtrante con polifosfati / Polyphosphate filter cartridge

• 95679

Altezza / height 10"



• 95680

Altezza / height 5"

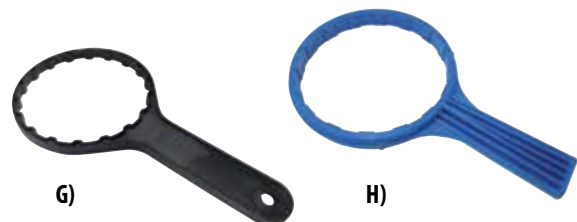
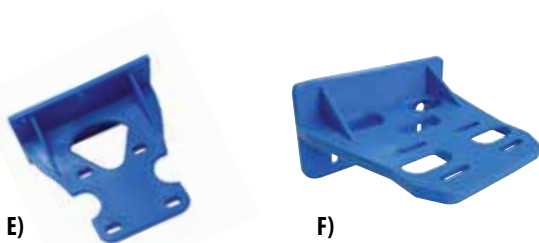

Staffa a parete / Wall bracket

• 95682

E) Per filtri da 5"



• 96716

F) Per filtri da 10"



Chiave apertura chiusura / Wrench

• 95683

G) Per filtri da 5"



• 96717

H) Per filtri da 10"





sistema controllo elettropompe control system



CE IP54



START & STOP

Sistema di controllo elettronico

Avvio e arresto automatico all'apertura o alla chiusura del rubinetto
 Portata costante
 Blocco della pompa per mancanza d'acqua
 Reset manuale
 Valvola non ritorno incorporata
 Per pompe con potenza tra 800 e 1200 watt
 Tens. monofase 230 volt
 Max ampere 10
 Max pressione esercizio 10 bar
 Max temperatura acqua 60 °C
 Portata massima 80 l/min
 Diam. max mandata 1.1/2"

Electronic pump control

Automatic start and stop by simply opening and closing tap
 Constant delivery
 Lock pump for absence of water
 Manual reset
 Built-in non-return valve
 For pump which power is between 800 and 1200 watts
 Voltage 230
 Max ampere 10
 Max pressure 10 bar
 Max water temperature 60 °C
 Max flow 80 l/min
 Max diam. delivery 1.1/2"

• 93255



8 000071 932554

elettropompe pumps



ELETTROPOMPE AUTOADESCANTI - BISENSO PER TRAVASO

Motore con invertitore, cavo e spina
 Albero acciaio inox
 Corpo pompa e girante in bronzo
 Tenuta ad anello in nitrile con molla inox
 Motore monofase 230V oppure trifase 220/380V
 Complete di raccordi

SELF PRIMING ELECTRIC PUMPS - TRANSFERT AND REVERSE

Motor with switchreverser and cable
 Stainless steel shaft
 Pump body and impeller of bronze Nitrile lip seal
 230 V single-phase or 220/380 V or three-phase motor
 With fittings

	Ø 20	Ø 25	Ø 30	Ø 35	Ø 40
Hp	0,3	0,6	1	1	1 ^{1/2}
Velocità g/min	2800	2800	1400	1400	1400
Portata lt/min	35	50	75	75	100
Prevalenza m	15	15	18	18	18

50848	Ø 20	8 000071 508483
50849	Ø 25	8 000071 508490
50850	Ø 30	8 000071 508506
50851	Ø 35	8 000071 508513
50852	Ø 40	8 000071 508520

53872 Carrello a richiesta / Truck optional



mod. PT 843

Motopompa autoadescente

Motore 2T - EURO2 - 42,7 cc
 Avviamento a strappo con autoavvolgente
 Carburante miscela 2%
 Capacità serbatoio lt 1,2
 Portata max 16 m³/h
 Prevalenza max 22 m
 Altezza max aspirazione 8 m
 Bocche aspirazione e mandata att. 40 mm
 Completa di raccordi
 Peso 9,5 Kg

Self priming
 Engine 2T - EURO2 - 42,7 cc
 Rewind Starter
 Mixture 2% (50:1)
 Fuel tank lt 1,2
 Water delivery 16 m³/h
 Max lift 22 m
 Max suction head 8 m
 Suction and delivery att. 40 mm
 With fittings
 Weight 9,5 Kg

• 94974



8 000071 949743



mod. WP 50

Motopompa

Motore OHV 4T - EURO2 - 196 cc
 Diametro uscita e entrata 50 mm
 Portata max 30 m³/h
 Prevalenza max 26 m
 Altezza max aspirazione 8 m
 Capacità serbatoio 3,6 litri
 Peso 21 Kg

Gasoline water pump
 Engine OHV 4T - EURO2 - 196 cc
 Inlet and outlet diameter 50 mm
 Water delivery 30 m³/h
 Max lift 26 m
 Max suction head 8 m
 Fuel tank 3,6 lt
 Weight 21 Kg

• 99067



8 000071 990677

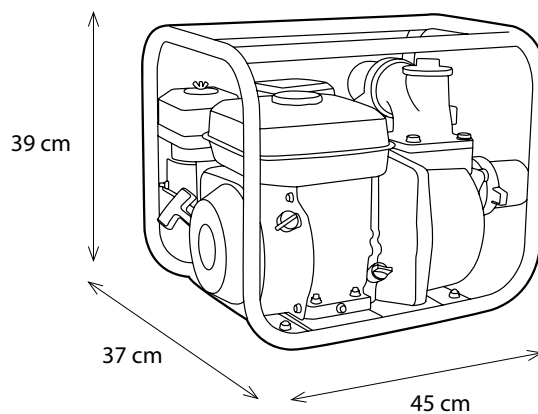

**elettropompa irroratrice** electric sprayer pump**Elettropompa irroratrice**

Su basamento
Motore elettrico monofase 1 HP
Pompa a membrana ad alta pressione
Portata: 15 lt min
Pressione: 20 atm.
Velocità (giri min): 1.400
Peso: 16 Kg

Motor-driven pump
With basement
Electric motor singlephase: 1 HP
High pression diaphragm
Discharge head: 15 lt min
Pressure: 20 atm.
Speed rpm : 1.400
Weight: 16 Kg

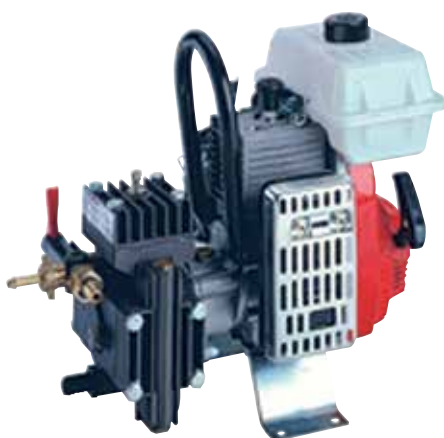
50847**motopompa irroratrice** power sprayer pump**mod. TRIAL-R****Motopompa irroratrice**

Su basamento
Motore 2T - 46 cc
Avviamento a strappo
Carburante (miscela): 5%
Pompa a membrana ad alta pressione con
valvola regolazione
Portata: 15 lt min
Pressione: 20 atm.
Velocità (giri min): 1.400
Peso: 10 Kg

Power sprayer
With basement
Engine 2T - 46 cc
Starter
Mixture: 5%
High pression diaphragm with pressure
reducing valve
Discharge head: 15 lt min
Pressure: 20 atm.
Speed rpm : 1.400
Peso/Weight: 10 Kg

50846**accessori per pompe** pump accessories**Vaso di espansione** / Spherical tank

A membrana per autoclavi
Capacità: 24 litri
Pressione max. esercizio: 5 bar
Pre carica: 1,5 bar

50872**Cestelli di fondo**

Per autoadescente

Foot basket

For self priming pumps

50923

att. 1"

50924

att. 1" 1/2



Pressostato / Pressure switch
 Con regolazione: 2 ÷ 3,5 bar
 Con differenziale: 0,8 bar

50873



Manometro / Manometre
 Scala: 0 ÷ bar
 Attacco radiale: 1/4"

50874



Raccordo a 5 vie / 5 way pipe union
 Per gruppo pompa/autoclave completo di riduzioni
 A richiesta fornibile il gruppo autoclave completo

50875



Portagomma nylon / Nylon hose connections
 Con filettatura cilindrica maschio

50898	3/4" x 20	50901	1"1/4 x 30
50899	1" x 25	50902	1"1/4 x 35
50900	1" x 30	50903	1"1/2 x 40



Raccordi nylon / Nylon connections
 Sede conica / Cone-seat
 Con portagomma dritto / Straight hose connection
 3 pezzi / 3 pcs

50878	3/4" x 20	50884	1"1/4 x 35
50879	1" x 25	50885	1"1/4 x 40
50880	1" x 30	50886	1"1/2 x 35
50881	1" x 35	50887	1"1/2 x 40
50882	1" x 40	50888	2" x 50
50883	1"1/4 x 30		



Portagomma nylon / Nylon hose connections
 Con attacco a ghiera filettata femmina e guarnizione piana

50904	3/4" x 20	50906	1"1/4 x 30
50905	1" x 25	50907	1"1/2 x 40



Valvole di fondo / Foot valves
 Mod. Yuri Nylon
 Attacchi femmina filettati gas cilindrici

50915	att. 3/4"	50916	att. 1"
--------------	-----------	--------------	---------



Raccordi nylon / Nylon connections
 Sede conica / Cone-seat
 Con portagomma curva / Bend hose connection
 3 pezzi / 3 pcs

51102	3/4" x 20	51108	1"1/4 x 35
51103	1" x 25	51109	1"1/4 x 40
51104	1" x 30	51110	1"1/2 x 35
51105	1" x 35	51111	1"1/2 x 40
51106	1" x 40	50974	2" x 50
51107	1"1/4 x 30		



Valvole di fondo / Foot valves
 Mod. Yuri Nylon
 Attacchi femmina filettati gas cilindrici

50917	att. 1"1/4	50919	att. 2"
50918	att. 1"1/2		



Raccordi nylon / Nylon connections
 Per tubo flessibile / For hose
 3 pezzi / 3 pcs

50891	Ø 20	50895	Ø 40
50892	Ø 25	50896	Ø 50
50893	Ø 30	50897	Ø 60
50894	Ø 35		



Filtri femmina / Filters F thread
 Mod. Nylon
 Filetto gas

50908	att. 1"	50910	att. 1"1/2
50909	att. 1"1/4		



Valvole di ritegno / Check valves
 Mod. Nylon - Attacchi femmina filettati gas cilindrici

50911	att. 1/2"	50913	att. 1"
50912	att. 3/4"		



tubi per irrigazione hoses for irrigation



Si allunga e si accorcia da solo

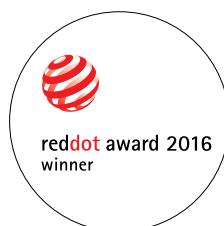

PRONTO ALL'USO

YOYO TI OFFRE TUTTI GLI ACCESSORI PER ESSERE SUBITO UTILIZZABILE

- A** Pistola multigetto ergonomica e compatta
- B** Raccordi con sistema aquastop
- C** Adattatore per il rubinetto

NUOVI RACCORDI E PISTOLA



Non si attorciglia e non si strozza



Pratico e flessibile



Zero peso, nessuna fatica



100% atossico



Salvaspazio e facile da riporre



Nessuna perdita

Temperatura di utilizzo: -10°C +50°C

YOYO è il sistema rosso per innaffiare e lavare subito pronto all'uso: completo di nuovi raccordi e pistola coordinati, YOYO è leggero, compatto, facile da usare.

Il tubo estensibile YOYO, con 5 anni di garanzia, assicura facilità di utilizzo e flusso d'acqua costante anche se schiacciato, senza nodi ed attorcigliamenti. Pratico da usare e comodo da avvolgere, il tubo può essere facilmente riposto anche in piccoli spazi. YOYO si completa di una pistola multifunzione compatta, leggera e adatta ad ogni mano che fa di YOYO il tubo idoneo per innaffiare l'orto e il giardino, per lavare mobili da esterno, biciclette, giocattoli, da portare in campeggio e in barca. Tubo e raccordi sono un tutt'uno garantendo l'assenza di perdite e l'assoluta tenuta dei raccordi, mentre il sistema di sicurezza Aquastop impedisce la fuoriuscita accidentale di acqua in pressione.

Premio Red Dot Design 2016

97774 8 metri * 8 011963 756677

97776 20 metri * 8 011963 756264

97775 15 metri * 8 011963 756240

97777 30 metri * 8 011963 756288

* Lunghezza in utilizzo / Length in use





FLEXO

Tubo monostrato atossico, molto flessibile, prodotto con l'aggiunta di un'essenza di citronella. Disponibile in colore esclusivo, superficie brillante e imballo personalizzato in foglia PE. Marcatura metrica progressiva.
Temperatura d'utilizzo -15° C / +50° C

Monolayer non-toxic hose, very flexible, product with addition of citronella aroma. Available in exclusive color, glossy surface and packing in PE film. Progressive metric marking.
Operating Temperature -15° C / + 50° C

55099	Ø 13x19 mm / 100 m	8 000071 550994
55100	Ø 15x21 mm / 100 m	8 000071 551007
55101	Ø 19x26 mm / 50 m	8 000071 551014
55102	Ø 22x30 mm / 50 m	8 000071 551021
55103	Ø 25x34 mm / 50 m	8 000071 551038
55104	Ø 30x40 mm / 50 m	8 000071 551045
55105	Ø 35x45 mm / 35 m	8 000071 551052
55106	Ø 40x50 mm / 35 m	8 000071 551069



DOUBLE THICK SYSTEM® KIT

KIT innaffio con raccordi
Con 20 metri di tubo

SPRINKLER KIT with fittings
With 20 m hose

86087	Ø 1/2" / 20 m	8 000071 860871
83830	Ø 5/8" / 20 m	8 000071 838306

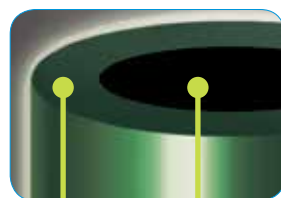

SPESSORE RADDOPPIATO
Double thickness

PROTEZIONE TOTALE ANTIALGA E ANTI-UV
Anti-algae and anti-UV total protection





tubi per irrigazione hoses for irrigation



DOUBLE THICK SYSTEM®

DOUBLE THICK SYSTEM®

è il nuovo sistema che elimina tutti i difetti dei tubi a basso spessore

Lo spessore del tubo infatti raddoppia alle due estremità, assicurando un collegamento ermetico ai raccordi e una tenuta perfetta

DOUBLE THICK SYSTEM®

system avoids usual problems encountered with lightweight hoses.

Hose thickness is double on the two ends, ensuring watertight connection with fittings and perfect tightness

51834	Ø 1/2" (12,5 mm) / 15 m	8 000071 518345
50813	Ø 1/2" (12,5 mm) / 25 m	8 000071 508131
51835	Ø 1/2" (12,5 mm) / 50 m	8 000071 518352
51836	Ø 5/8" (15 mm) / 15 m	8 000071 518369
50814	Ø 5/8" (15 mm) / 25 m	8 000071 508148
51837	Ø 5/8" (15 mm) / 50 m	8 000071 518376
50816	Ø 3/4" (19 mm) / 25 m	8 000071 508162
51838	Ø 3/4" (19 mm) / 50 m	8 000071 518383



Ai distacchi dei raccordi

Disconnection from the fittings



Alle rotture

Hose breaks



Alle perdite d'acqua

Water leaks



Alle pieghe

Kink in hoses

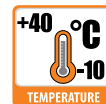

SPESORE RADDOPPIATO
Double thickness

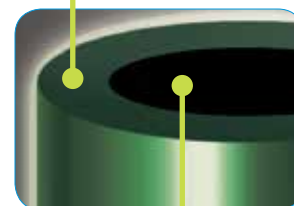

PROTEZIONE TOTALE ANTIALGA E ANTI-UV

Anti-algae and anti-UV total protection



FLEXYMAT®

Tubo da giardino per uso hobbistico, flessibile e estremamente facile da usare. Copertura esterna di colore giallo coprente con riga verde, strato intermedio di sostegno bianco e strato nero interno che assicura una protezione totale anti-alga. Temperatura d'utilizzo -10° C / +40° C

Garden hose for home use, flexible and extremely easy to use. Outer covering in yellow with green stripe, intermediate support layer in white color, interior layer in black that ensures total protection against algae. Operating Temperature -10 °C / +40 °C

55620	Ø 1/2" (12,5 mm) / 25 m	8 000071 556200
55622	Ø 5/8" (15 mm) / 15 m	8 000071 556224
55623	Ø 5/8" (15 mm) / 25 m	8 000071 556231
55624	Ø 5/8" (15 mm) / 50 m	8 000071 556248
55625	Ø 3/4" (19 mm) / 25 m	8 000071 556255
55626	Ø 3/4" (19 mm) / 50 m	8 000071 556262





tubi per irrigazione hoses for irrigation

NTS® WINTECH Plus

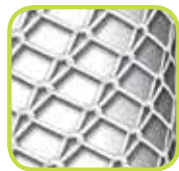

Rinforzo Brevettato NO TORSION SYSTEM
Patented No Torsion System reinforcement



Idoneo per il passaggio di acqua potabile **
Suitable for drinking water



PROTEZIONE TOTALE ANTIALGA E ANTI-UV
Anti-algae and anti-UV total protection



GUARDA IL VIDEO



* < 0,1%
** Secondo il Reg. (EU) 10/2011 Simulante A

NTS® WINTECH Plus



NTS® Wintech Plus SI ARROTOLA E SROTOLA AL CARRELLO CON GRANDE FACILITÀ
EASY RO ROLL AND UNROLL ON THE TROLLEY



NTS® WINTECH PLUS

Il nuovo tubo NTS® Wintech Plus, impiega la speciale formulazione Phthalate Free che sostituisce gli ftalati con plastificanti di elevata qualità e stabilità. Idoneo per il passaggio di acqua potabile, il tubo NTS® Wintech Plus utilizza la tecnologia brevettata FITT® – No Torsion System.

Il sistema NTS®, grazie all'esclusiva magliatura di rinforzo ad andamento elicoidale, è in grado di garantire:

- Assenza di nodi e pieghe durante l'uso
- Flusso costante dell'acqua
- Resiste a pressioni elevate (fino a 30 bar)
- Maneggevolezza e facilità di utilizzo

The new NTS® Wintech Plus product special formulation Phthalate Free replacing phthalate plasticizers with high quality and stability. Suitable for the passage of drinking water, the hose NTS® Wintech Plus use patented FITT® – No Torsion System.

NTS® system, thanks to the exclusive helicoidal stitch reinforcement guarantee:

- Absence of knots and folds during use
- Constant water flow
- High pressure resistant (up to 30 bar)
- Manageability and ease of use

52610	Ø 1/2" (12,5 mm) / 15 m	max bar 30	 8 000071 526104
52611	Ø 1/2" (12,5 mm) / 25 m	max bar 30	 8 000071 526111
52612	Ø 1/2" (12,5 mm) / 50 m	max bar 30	 8 000071 526128
52613	Ø 5/8" (15 mm) / 15 m	max bar 25	 8 000071 526135
52614	Ø 5/8" (15 mm) / 25 m	max bar 25	 8 000071 526142
52615	Ø 5/8" (15 mm) / 50 m	max bar 25	 8 000071 526159
52616	Ø 3/4" (19 mm) / 25 m	max bar 24	 8 000071 526166
52617	Ø 3/4" (19 mm) / 50 m	max bar 24	 8 000071 526173
52618	Ø 1" (25 mm) / 25 m	max bar 22	 8 000071 526180
52619	Ø 1" (25 mm) / 50 m	max bar 22	 8 000071 526197



tubi speciali special hoses



ECODROP

Tubo poroso

Adatto ad irrigare aiuole, cespugli, orti, alberi.
 Utilizzabile sia in superficie che interrato.
 La struttura microporosa consente una trasudazione uniforme, capillare e senza spruzzi con un risparmio notevole d'acqua fino al 70%.
 Pressione massima d'esercizio 3 bar.
 Set da irrigazione completo di tappo e riduttore di pressione

Porous hose

To irrigate surfaces or underground flower-beds, hedges, gardens and trees.
 The microporous material allows uniform transpiration, without spray, saving time and water up to 70% overall.
 3 max pressure working bar.
 Set for irrigation including cap and pressure reducer

55037	Ø 1/2" / 7,5 m	
55038	Ø 1/2" / 15 m	



ALI-FLEX

Tubo spiralato

Tubo flessibile in PVC plastificato con spirale in rinforzo in PVC rigido anti urto.
 Può essere utilizzato in condizioni non gravose nel settore alimentare, industriale e agricolo. Destinato all'aspirazione e mandata a bassa pressione.
 Alimentare in conformità alla Direttiva Europea 2007/19/EC per i simulanti A-B-C
 Temperatura d'impiego da -10 a +50° C.

Spiral hose

Flexible plasticized PVC hose with reinforcement spiral in rigid shock resistant PVC.
 To be used in non heavy work situations in the food, industrial and agricultural sectors.
 For low pressure suction and delivery.
 Operating temperature from -10 to +50°C.

	Ø interno mm	pressione massima d'esercizio (bar)
54687	20	7
50805	25	7
50806	30	7
50807	35	6
50808	40	6
50809	50	6
50810	60	5
50811	80	4
50812	100	4



Realizzati in lamiera e acciaio
Raccordi in ottone

Made of steel
Brass connectors

• 93125

50 m x tubo da 1/2"



• 93126

80 m x tubo da 1/2"
50 m x tubo da 3/4"



Per 50 metri di tubo da 1/2"
Realizzato in lamiera e acciaio verniciati
Raccordi in ottone

For 50 m x 1/2" hose
Made of coated steel
Brass connectors

• 93987



Per 80 metri di tubo da 1/2"
(50 m da 3/4")
Realizzato in lamiera e acciaio verniciati
Raccordi in ottone

For 80 m x 1/2" hose (or 50 m x 3/4")
Made of coated steel
Brass connectors

• 93988



Per 80 metri di tubo da 3/4"
Realizzato in lamiera e acciaio verniciati
Ruote pneumatiche
Raccordi in ottone

For 80 m x 3/4"
Made of coated steel
Pneumatic wheels
Brass connectors

• 93989





avvolgitubi carrellati hose trolleys



Per 45 metri di tubo da 1/2"
Tamburo in polipropilene antiurto
Telaio in acciaio verniciato a polveri
Resistente alla corrosione e alla ruggine

For 45 m x 1/2" hose
High polypropylene construction
Epoxy painted steel frame
Rust and corrosion resistant

• 86572



Per 60 metri di tubo da 1/2"
Tamburo in polipropilene antiurto
Telaio in acciaio verniciato a polveri
Resistente alla corrosione e alla ruggine

For 60 m x 1/2" hose
High polypropylene construction
Epoxy painted steel frame
Rust and corrosion resistant

• 82018



Guida per il riavvolgimento del tubo



Per 50 metri di tubo da 1/2"
Tamburo in plastica
Telaio in acciaio verniciato
Pratica guida per il riavvolgimento del tubo
Solida vaschetta portaoggetti

For 50 m x 1/2" hose
High plastic construction
Painted steel frame
Practical guide to the hose rewind
Solid storage tray

• 94606





Avvolgitubo murale portatile

Per 50 metri di tubo da 1/2"

Con supporto a parete

Raccordi portagomma in ottone

Portable wall hose reel

For 50 m x 1/2" hose

With wall bracket

Brass connectors

• 96844



Avvolgitubo 2 usi

Portatile e a muro

Corpo in materiale plastico antiurto

Maniglia in gomma morbida

Peso 3,5 Kg

2 way hose reel

Free standing and wall mounted

Antichoc, plastic body

Handle with soft rubber grip

Weight 3,5 Kg

Completo di:

- 15 m tubo PVC 11bar Ø 1/2"
- 1,5 m tubo raccordo
- 3 raccordi rapidi
- pistola innaffio 5 getti
- viti e tasselli per montaggio a parete

With:

- 15 m PVC hose 11 bar Ø 1/2"
- 1,5 m hose connector
- 3 hose connectors
- water nozzle 5-way
- screws and plugs for wall mounted

• 93178



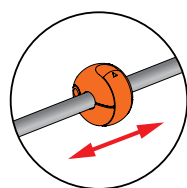

avvolgitubo hose reel

**Sfera d'arresto regolabile.**

La sfera di arresto impedisce al tubo di riavvolgersi all'interno dell'avvolgitubo. È possibile posizionarla ovunque a seconda delle esigenze, rendendo il tubo facilmente raggiungibile.

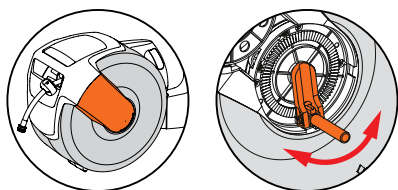
**Forza della molla regolabile grazie alla manovella.**

Aumentando o riducendo la tensione è possibile regolare la forza della molla, questo contribuisce a un efficiente funzionamento dell'avvolgitubo nel tempo.

**Avvolgitubo automatico a muro**

Funzione di stop del tubo in ogni punto
Rientro del tubo rallentato
Sfera d'arresto regolabile
Forza della molla regolabile
Rotazione di 180°
Corpo in materiale plastico antiurto
Staffa di aggancio al muro in alluminio
Peso 9 Kg

Wall automatic hose reel

Stop at anywhere
Slow return
Adjustable stop-ball
Adjustable spring
180° swivel when mounted on wall
Antichoc, plastic body
Aluminium alloy bracket
Weight 9 Kg

Completo di:

- 20 m tubo PVC 11bar Ø 1/2"
- 2 m tubo raccordo 3/4"
- lancia innaffio regolabile

With:

- 20 m PVC hose 11 bar Ø 1/2"
- 2 m hose with connector 3/4"
- adjustable spray nozzle

• 92926



8 000071 929264

**Mini kit avvolgitubo**

Struttura in plastica
Tubo da 3/8" per 10 metri
2 connettori rapidi
1 pistola a 7 funzioni
Predisposizione per il montaggio a muro
Compatto e leggero

Mini kit hose reel

Plastic frame
10 m x 3/8" hose
2 hose connector
1 hose nozzle 7 function
Suitable for wall mounting
Compact and lightweight

• 94607



8 000071 946070



Supporto da parete
In polipropilene

Hose hanger
Polypropylene material

• 84385



Supporto da parete
In lamiera e acciaio

Hose hanger
Steel

• 96845



extensible hose **tubi estensibili**



Tubo estensibile per inaffio

Adatto per terrazze e piccoli giardini
Non necessita di avvolgitubo
Lunghezza 15 m
Sezione del tubo 10x12 mm
Pressione d'esercizio 8 bar
Completo di due raccordi rapidi

Extensible hose for irrigation
For terraces and small garden
Don't need hose reel
Length 15 m
Hose section 10x12 mm
Working pressure 8 bar
With two hose connectors

• 89185



Tubo estensibile per inaffio con lancia

Adatto per terrazze e piccoli giardini
Non necessita di avvolgitubo
Lunghezza 15 m
Sezione del tubo 10x12 mm
Pressione d'esercizio 8 bar
Completo di due raccordi rapidi
Completo di lancia a 7 getti, mod. Lusso
Pressione d'esercizio 8 bar

Extensible hose for irrigation
with water nozzle
For terraces and small garden
Don't need hose reel
Length 15 m
Hose section 10x12 mm
Working pressure 8 bar
With two hose connectors
With water nozzle 7 way, Luxury type
Working pressure 8 bar

• 90155





accessori per innaffio water nozzle series



Raccordi rapidi
(conf. appendibile)

Hose connectors
(hanging pack.)

• 81143	1/2"	
• 92547	5/8"	
• 81144	3/4"	



ACQUA STOP



Raccordi rapidi
Acquastop (conf. appendibile)

Hose connectors
Auto shut-off (hanging pack.)

• 82024	1/2"	
• 92548	5/8"	
• 82028	3/4"	

Ø 1/2"
5/8" - 3/4"



Raccordo rapido universale
(conf. appendibile)

Multisize hose connector
(hanging pack.)

• 95410	1/2" - 5/8" - 3/4"	
---------	--------------------	--



Raccordi giunzione
(conf. appendibile)

Hose menders
(hanging pack.)

• 82023	1/2"	
• 81145	3/4"	

Ø 1/2"
5/8" - 3/4"



Raccordo giunzione universale
(conf. appendibile)

Multisize hose mender
(hanging pack.)

• 95411	1/2" - 5/8" - 3/4"	
---------	--------------------	--



Innesto rapido

Filetto 3/4" M (conf. appendibile)

Tap connectors

3/4" thread M (hanging pack.)

• 82022



Innesto rapido

Filetto 3/4" femmina
Riduzione MF 3/4" - 1/2"
(conf. appendibile)

Tap connectors

3/4" F thread
Reducer 3/4" to 1/2"
(hanging pack.)

• 82021



(versione sfusa)

(loose series)

• 92549



Giunzione a 2 innesti

Maschio (conf. appendibile)

Coupling couplers 2 way
Male (hanging pack.)

• 82025



Innesto rapido

Filetto 1" femmina
Riduzione MF 1" - 3/4"
(conf. appendibile)

Tap connectors

1" F thread
Reducer 1" to 3/4"
(hanging pack.)

• 87356



Giunzione a 3 innesti

Maschio (conf. appendibile)

Coupling couplers 3 way
Male (hanging pack.)

• 82026



esempio di confezione appendibile



esempio di confezione (display box) per accessori versione sfusa



accessori per innaffio water nozzle series

**Rubinetto di linea**

Filetto 3/4" (conf. appendibile)

One way shut-off
3/4" thread (hanging pack.)

• 83743



8 000071 837439

**Presa a doppio rubinetto**

2 innesti maschi (conf. appendibile)

Dual shut-off connector
2 male (hanging pack.)

• 83744



8 000071 837446

**Presa a doppio rubinetto**

Utilizzo di 1 o 2 rubinetti di uscita contemporanea

Filetto 3/4" F

2 attacchi filetto 3/4" M

Dual shut-off connector
Use one or two hoses from one faucet
3/4" F thread
to two 3/4" M thread connections

• 82027



8 000071 820271

**Distributore a 4 vie**

Con rubinetti

2 uscite 3/4" M innesto rapido

+ 2 innesto rapido diretto (conf. appendibile)

4 way water distributor

With taps

Two 3/4" male way

+ two hose connectors (hanging pack.)

• 86934



8 000071 869348



Raccordi rapidi
con ghiera filettata
(conf. appendibile)

Hose connectors
with threaded ring
(hanging pack.)

• **91664** 1/2" 8 000071 916646

• **91666** 3/4" 8 000071 916660

(versione sfusa)

(loose series)

• **92145** 1/2" 8 000071 921459

• **92546** 5/8" 8 000071 925464

• **92146** 3/4" 8 000071 921466



Raccordi rapidi
con ghiera filettata
Acquastop (conf. appendibile)

Hose connectors
with threaded ring
Auto shut-off (hanging pack.)

• **91665** 1/2" 8 000071 916653

• **91667** 3/4" 8 000071 916677

(versione sfusa)

(loose series)

• **94635** 1/2" 8 000071 946353

• **94634** 5/8" 8 000071 946346

• **94636** 3/4" 8 000071 946360



Raccordo rapido universale
(conf. appendibile)

Multisize hose connector
(hanging pack.)

• **95412** 1/2" - 5/8" - 3/4" 8 000071 954129



Ø 1/2"
5/8" - 3/4"



SOFT TOUCH

**Materiale bicomponente antisdrucciolevole
soffice al tatto**

Bicomponent material - antislip, soft touch



accessori per innaffio water nozzle series



Raccordi rapidi
con manicotto filettato
(conf. appendibile)

Hose connectors
with threaded ring sleeve
(hanging pack.)

• 90149	1/2"	
• 90151	3/4"	



Raccordi rapidi
con manicotto filettato
Acquastop (conf. appendibile)

Hose connectors
with threaded ring sleeve
Auto shut-off (hanging pack.)

• 90150	1/2"	
• 90152	3/4"	



Raccordi giunzione
(conf. appendibile)

Hose menders
(hanging pack.)

• 91662	1/2"	
• 91663	3/4"	
(versione sfusa)	(loose series)	
• 92147	1/2"	
• 92148	3/4"	



Innesti rapidi MF
(conf. appendibile)

Tap adaptors
(hanging pack.)

• 91660	1/2"	
• 91661	3/4"	
(versione sfusa)	(loose series)	
• 94632	1/2"	
• 94633	3/4"	



Innesti rapidi

Filetto maschio (conf. appendibile)

Tap connectors

Male thread (hanging pack.)

• 88349

1/2"



8 000071 883498

• 88350

3/4"



8 000071 883504



Innesti rapidi

Filetto femmina (conf. appendibile)

Tap connectors

Female thread (hanging pack.)

• 88346

1/2"



8 000071 883467

• 88347

3/4"



8 000071 883474

• 88348

1"



8 000071 883481



Raccordi giunzione

(conf. appendibile)

Hose menders

(hanging pack.)

• 88352

1/2"



8 000071 883528

• 92515

5/8"



8 000071 925150

• 88353

3/4"



8 000071 883535



Raccordi rapidi

(conf. appendibile)

Hose connectors

(hanging pack.)

• 88344

1/2"



8 000071 883443

• 92514

5/8"



8 000071 925143

• 88345

3/4"



8 000071 883450



Raccordi rapidi

Acquastop (conf. appendibile)

Hose connectors

Auto shut-off (hanging pack.)

• 88342

1/2"



8 000071 883429

• 92513

5/8"



8 000071 925136

• 88343

3/4"



8 000071 883436



ACQUA STOP



accessori per innaffio in ottone water nozzle brass series

**Pres a doppio rubinetto**

Filetto 3/4" F

2 innesti rapidi
(conf. appendibile)

Dual shut-off

3/4" F thread

2 male way
(hanging pack.)

• 88354



8 000071 883542

**Pres a doppio rubinetto**

Filetto 3/4" F

2 attacchi filettati 3/4" maschio
(conf. appendibile)

Dual shut-off

3/4" F thread

2 male way 3/4" thread
(hanging pack.)

• 88355



8 000071 883559

**Giunzione 2 innesti**

Maschio (conf. appendibile)

2 way connector

Male (hanging pack.)

• 88351

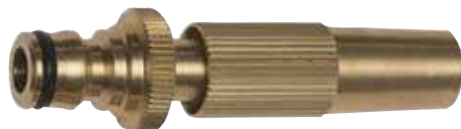

8 000071 883511

**Lancia in ottone**

A getto regolabile (conf. appendibile)

Brass hose nozzle

Adjustable spray (hanging pack.)

• 88356

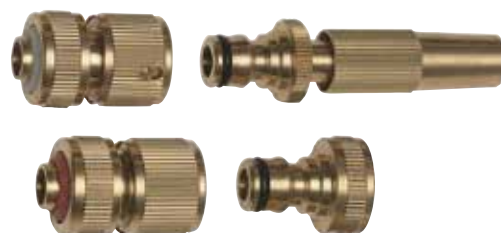

8 000071 883566

**Set lancia in ottone**

con raccordi (conf. appendibile)

Brass set

with hose connectors (hanging pack.)

• 88357



8 000071 883573



Lancia A getto regolabile (conf. appendibile)	Hose nozzle Adjustable spray (hanging pack.)
• 82010	 8 000071 820103



Set lancia Per tubi da 1/2" Con raccordi rapidi "acquastop" (conf. appendibile)	Nozzle set For 1/2" hose With auto shut-off hose connectors (hanging pack.)
• 82013	 8 000071 820134



Lance diritte getto regolabile (conf. appendibile)	Hose nozzle Adjustable spray (hanging pack.)
• 90153	 8 000071 901536
(versione sfusa)	(loose series)
• 92149	 8 000071 921497





lance e pistole per innaffio spray nozzles and pistols



mod. LUSSO

Struttura in metallo e ottone
Manico bicomponente antiscivolo
Getto regolabile (conf. appendibile)

Metal and brass frame
Bimaterial antislip handle
Adjustable spray (hanging pack.)

• 88374



mod. LUSSO

Multifunzione
Struttura in metallo e ottone
Manico bicomponente antiscivolo
A 6 getti (conf. appendibile)

Multifunction
Metal and brass frame
Bimaterial antislip handle
6 nozzle spray (hanging pack.)

• 88375



mod. EXTRA

Struttura in metallo e ottone
Manico PVC trasparente antiscivolo
Getto regolabile (conf. appendibile)

Metal and brass frame
PVC transparent non-slip handle
Adjustable spray (hanging pack.)

• 90156



mod. EXTRA

Struttura in metallo e ottone
Manico PVC trasparente antiscivolo
8 getti regolabili (conf. appendibile)

Metal and brass frame
PVC transparent non-slip handle
8 adjust. shower spray (hanging pack.)

• 90157





spray nozzles and pistols **lance e pistole per innaffio**



Struttura in metallo
Impugnatura ergonomica e antiscivolo
Getto regolabile (conf. appendibile)

Metal frame
Ergonomic and antislip handle
Adjustable spray (hanging pack.)

• 95045



Multifunzione
Struttura in metallo
Impugnatura ergonomica e antiscivolo
A 7 getti (conf. appendibile)

Multifunction
Metal frame
Ergonomic and antislip handle
7 nozzle spray (hanging pack.)

• 95044



Getto regolabile
Impugnatura ergonomica
(conf. appendibile)

Adjustable spray
Ergonomic handle
(hanging pack.)

• 94627



Multifunzione
A 10 funzioni d'innaffio
Impugnatura ergonomica
(conf. appendibile)

Multifunction
10 pattern
Ergonomic handle
(hanging pack.)

• 94628





lance e pistole per innaffio spray nozzles and pistols



In lega Alloy metal
A getto regolabile (conf. appendibile) Adjustable spray (hanging pack.)

• 88358



Lancia a pistola Water nozzle
A getto regolabile (conf. appendibile) Adjustable spray (hanging pack.)

• 82011



Lancia a pistola regolabile Adjustable gun nozzle
(conf. appendibile) (hanging pack.)

• 86391



Lancia a pistola regolabile Adjustable gun nozzle
2 regolazioni (conf. appendibile) 2 way (hanging pack.)

• 86392





Lancia a pistola
A 8 getti (conf. appendibile)

Gun nozzle
8 nozzles (hanging pack.)

• 83648



Pistola combinata
4 funzioni (conf. appendibile)

Shower spray nozzle
4 way (hanging pack.)

• 86389



Set lancia a pistola
Per tubi da 1/2"
Con raccordi rapidi "acquastop"
(conf. appendibile)

Water nozzle set
For 1/2" hose
With auto shut-off hose connectors
(hanging pack.)

• 82014



Pistola combinata
A doccia con raccordi rapidi
"acquastop" (conf. appendibile)

Shower spray nozzle
With auto shut-off hose connectors
(hanging pack.)

• 82012





lance e pistole per innaffio spray nozzles and pistols

2in1

Twist



Guarda il video sul tuo smartphone

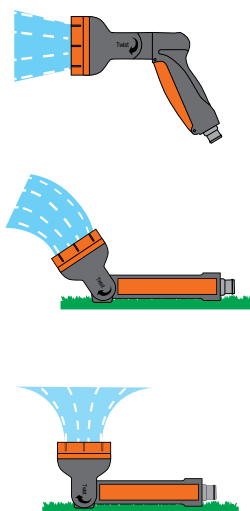

Pistola multifunzione e irrigatore – 2in1

Funzione TWIST – la pistola all'occorrenza si trasforma in un pratico irrigatore, semplicemente ruotando l'angolo della testa.

4 getti d'acqua differenti.

Leva ON/OFF con blocco.

Superficie irrigata fino a 66 m² ca.

2in1 – Multifunction spray gun and sprinkler
TWIST function – the spray gun can be converted into a practical lawn sprinkler, simply turning the angle of the head.

4 different spray patterns.

Lockable ON/OFF trigger.

Irrigation surface area up to 66 m² ca.

• 99182



Twist

La testa della pistola multigetto può essere girata di 45° o 90° in modo da potere utilizzare la pistola come irrigatore appoggiandola a terra. Con l'angolo di 45° il getto a doccia è perfetto per irrigare i vasi mentre a 90° si utilizza il getto a nebulizzatore per irrigare un'area più ampia.



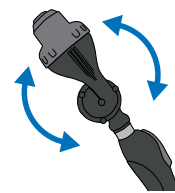

testa orientabile

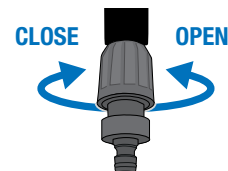

Regolazione del flusso d'acqua



Lancia per innaffio telescopica

Lunghezza fino a 183 cm

2 getti d'acqua

Testa girevole

Regolazione del flusso di acqua ad una mano

Funzione di apertura e chiusura (ON/OFF)

Corpo in alluminio

Telescopic water blaster

Extends up to 183 cm

2 different spray patterns

Swivel head

Adjusting the flow of water with one hand

Function of opening and closing (ON / OFF)

Aluminum body

• 97859



Doccia per innaffio multifunzione

6 funzioni

Tubo telescopico in alluminio

Lunghezza 55÷90 cm

Testa rotante 180° (conf. appendibile)

Spray Lance - multifunction

6 patterns

Telescopic aluminium pipe

Length 55÷90 cm

180° orientable head (hanging pack.)

• 81147





lance e pistole per innaffio spray nozzles and pistols

**Set spazzola lavaggio**Con lancia e raccordi
(conf. appendibile)Gun and spray brush set
With hose and connectors
(hanging pack.)

• 82020



doccia per giardino garden shower

doccetta con snodo 180°
shower with joint 180°In alluminio - 3 sezioni
Completa di treppiede, puntale e rubinetto
Doccetta con snodo 180°Aluminium tubular - 3 sections
With tripod, spike and tap
Shower with joint 180°

• 86936

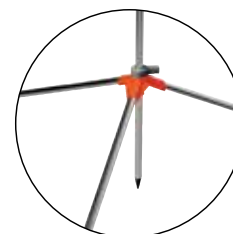
rubinetto di regolazione
tap controltreppiedi con puntale centrale
tripod with central spike

misuratore di portata water flow meter

**Misuratore di portata idrica**Display LCD / Attacchi rapidi
Funziona con 1 batteria di tipo CR2032 da 3V
(inclusa)
(conf. appendibile)Water flow meter
LCD display
Quick connectors
Works with 1 CR2032 3V battery (included)
(hanging pack.)

• 93905





Timer meccanico

Regolazione Timer da 5 a 120 minuti
Spegnimento automatico
Comando apertura manuale
Per rubinetti con filetto da 3/4" e 1"
Pressione d'esercizio 0.5-12 bar
Funziona senza batterie

Mechanical water timer
Set from 5 minutes to 120 minutes
Automatic shut-off
Manual override function
For taps with 3/4" and 1" thread
Operating pressure 0.5-12 bar
No batteries required

• 97860



Timer meccanico a 3 vie

Regolazione Timer da 5 a 120 minuti
Spegnimento automatico
Comando apertura manuale
Per rubinetti con filetto da 3/4" e 1"
Pressione d'esercizio 0.5-12 bar
Funziona senza batterie

3-way Mechanical water timer
Set from 5 minutes to 120 minutes
Automatic shut-off
Manual override function
For taps with 3/4" and 1" thread
Operating pressure 0.5-12 bar
No batteries required

• 97861



Con valvola a sfera meccanica
Comando apertura manuale
Frequenza ripetizione:
= da 1 a 72 ore
= settimanale
Durata inaffio:
= da 1 a 120 minuti
Funzionamento con 2 batterie stilo tipo AA
(non include)

With ball valve
ON/OFF manual control
Repetition frequency:
= to 1 from 72 hours
= weekly
Run time:
= to 1 from 120 minutes
2 batteries AA function
(not included)

• 93182



Con orologio

Con valvola a sfera meccanica
Comando apertura manuale
Frequenza ripetizione:
= da 6 a 72 ore
= settimanale
Durata inaffio:
= da 1 a 180 minuti
Funzionamento con 2 batterie stilo tipo AA
(non include)

With clock
With ball valve
ON/OFF manual control
Repetition frequency:
= to 6 from 72 hours
= weekly
Run time:
= to 1 from 180 minutes
2 batteries AA function
(not included)

• 95047





programmatori analogici mechanical timers



Timer elettronico con valvola solenoide
Comando apertura manuale
Frequenza ripetizione:
= da 1 a 72 ore
= settimanale
Durata innaffio:
= da 1 a 120 minuti
Funzionamento con 2 batterie AA
(non incluse)

Electronic timer with solenoid valve
ON/OFF manual control
Repetition frequency:
= to 1 from 72 hours
= weekly
Run time:
= to 1 from 120 minutes
2 batteries AA function (not included)

• 93183



programmatori digitali electronic timers



Con valvola solenoide
Display a cristalli liquidi
Comando apertura manuale
Ciclo innaffio giornaliero
Regolazione giorno-settimana
Regolazione durata tempo innaffio
Regolazione ora di attivazione
Funzionamento con 1 batteria 9V (non inclusa)

With solenoid valve
LCD panel
ON/OFF manual control
Daily watering
Day-week regulation
Time watering regulation
Starting hour regulation
1 battery 9V function (not included)

• 93184



Programmatore bizona (2 uscite) con valvola solenoide
Display a cristalli liquidi
Ciclo di innaffio giornaliero
Regolazione giorno-settimana
Regolazione durata tempo innaffio
Regolazione ora di attivazione
Funzionamento con 1 batteria 9V (non inclusa)

Timer 2 out-put with solenoid valve
LCD panel
Daily watering
Day-week regulation
Time watering regulation
Starting hour regulation
LCD display, 1 9V battery function (not included)

• 93185





Irrigatore a farfalla

Puntale plastica (conf. appendibile)

Butterfly rotary sprinklers
Plastic spike (hanging pack.)

• 85980



Irrigatore statico

Con puntale e 4 testine per irrigazione parziale o totale

Stationary sprinklers
Plastic spike and 4 spray patterns

• 83746



Irrigatore statico

Base tonda

Stationary sprinklers
Round base

• 87762



Irrigatore rotante a girella

Superficie irrigata 90 m² ca.
(conf. appendibile)

Rotary sprinkler
Irrigation surface 90 m² ca.
(hanging pack.)

• 86386



Irrigatore rotante

In plastica
Superficie irrigata 90 m² ca.
(conf. appendibile)

Rotary sprinkler
In plastic
Irrigation surface 90 m² ca.
(hanging pack.)

• 85981





irrigatori sprinklers



Irrigatore rotante
Base in zama
Superficie irrigata 100 m² ca.

Alloy metal rotary sprinkler
Zamak base
Irrigation surface 100 m² ca.

• 89110



Irrigatore rotante
Con base a slitta in plastica
Superficie irrigata 120 m² ca.

Rotary sprinkler
With plastic sled base
Irrigation surface 120 m² ca.

• 83652



Irrigatore rotante
Superficie irrigata 120 m² ca.
Puntale in plastica (conf. appendibile)

Rotary sprinkler
Irrigation surface 120 m² ca.
Plastic spike (hanging pack.)

• 86387



Irrigatore oscillante
Struttura in alluminio e plastica
Con 15 ugelli
Turbina brevettata
Superficie irrigata 180 m² ca.

Oscillating sprinkler
Aluminium and plastic frame
15 holes
Patented gear mechanism
Irrigation surface 180 m² ca.

• 86413





Irrigatore oscillante a turbina

Struttura in plastica
 Con 16 ugelli
 Superficie irrigata 255 m² ca.
 Regolazione angolo 0°~94°
 Tappo a spillo per la pulizia dei fori

Turbo oscillating sprinkler
 Plastic frame
 16 holes
 Irrigation surface 255 m² ca.
 Spray angle control 0°~94°
 Cleaning needle

• 95479



impulse sprinklers irrigatori a settori



Costruito in ABS
 Attacco gas 1/2" M
 Per irrigazione a bassa pressione
 Pressione 2 - 6 atm
 Sup. irrigata 490÷897 m² ca.

ABS material
 Gas thread 1/2" M
 For low water pressure
 Pressure atm 2 - 6
 Coverage 490÷897 m² ca.

• 83650

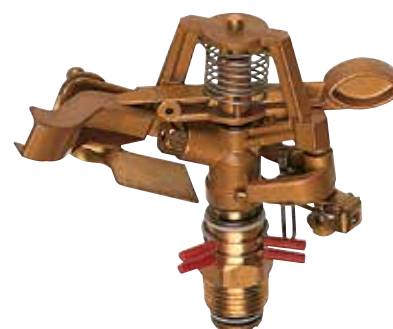

Modello in zinco/ottone
 Attacco gas 1/2" M
 Per irrigazione a bassa pressione
 Pressione 2 - 6 atm
 Sup. irrigata 490÷897 m² ca.

Material of zinc & brass
 Gas thread 1/2" M
 For low water pressure
 Pressure atm 2 - 6
 Coverage 490÷897 m² ca.

• 83741



Modello in metallo con slitta in plastica
 Per irrigazione a bassa pressione
 Pressione 2 - 6 atm
 Sup. irrigata 490÷897 m² ca.

Material of zinc & brass with plastic H base
 For low water pressure
 Pressure atm 2 - 6
 Coverage 490÷897 m² ca.

• 83651





irrigatori a settori impulse sprinklers



Testa e puntale in materiale plastico
 Attacco gas 1/2" M
 Per irrigazione a bassa pressione
 Pressione 2 - 6 atm
 Superficie irrigata 86 m² ca.
 Regolazione 20°-360°

Plastic head and spike base
 Thread connector 1/2" M
 For low water pressure
 Pressure atm 2-6
 Irrigation surface 86 m² ca.
 Adjustable from 20° to 360°

• 95046



Con treppiede (cod. 88340)
 Costruzione in metallo
 Attacco gas 1/2" F
 Per irrigazione a bassa pressione
 Pressione 2 - 6 atm
 Sup. irrigata 490÷897 m² ca.
 Regolazione 0-360° o settori

With tripod (cod. 88340)
 Metal construction
 Gas thread 1/2" F
 For low water pressure
 Pressure atm 2 - 6
 Coverage 490÷897 m² ca.
 Adjustable from 0 to 360°

• 88341



Treppiede regolabile
 In metallo zincato con accessori in plastica
 Attacco gas 1/2" F
 Altezza regolabile 51-84 cm

Adjustable tripod
 Zinc plated with plastic accessories
 Gas thread 1/2" F
 Height adjustable 51-84 cm

• 88340





mod. JUNIOR

Costruito in ottone, lega leggera e delrin
 Attacco a vite 1/2" M
 Ugelli Ø 4 mm
 Per irrigazione a bassa pressione di vigneti,
 frutteti e per la protezione antibirina

Made off brass, aluminium and delrin
 Screw connection 1/2" M
 Nozzle Ø 4 mm
 Suitable for irrigating gardens and orchards at low pressure
 and anti-frost protection



Ugello Ø mm	Press. atm.	Gittata m	Litri/sec	Sup. m ²
4	1,5	10,-	0,15	314
	2,-	11,-	0,18	380
	2,5	12,-	0,20	452
	3,-	12,5	0,22	490
	4,-	13,5	0,25	572

50820



mod. SILVER

Costruito in ottone e lega leggera
 Attacco a vite 3/4" M
 3 ugelli Ø 4-5-6 mm
 Per irrigazione con piccola portata, a medie e basse
 pressioni

Made off brass and aluminium
 Screw connection 3/4" M
 3 nozzles Ø 4-5-6 mm
 Small discharge operating at low and medium pressures



Ugello Ø mm	Press. atm.	Gittata m	Litri/sec	Sup. m ²
4	1,5	11,-	0,15	380
	2,-	12,-	0,18	452
	3,-	13,5	0,22	572
	4,-	14,5	0,25	660
5	1,5	12,5	0,31	490
	2,-	13,5	0,36	572
	3,-	15,-	0,44	706
6	4,-	16,-	0,51	804
	2,-	14,5	0,38	660
	3,-	16,-	0,64	804
	4,-	17,-	0,74	907
	4,5	17,5	0,78	962

50822



mod. FUNNY

Costruito in ottone e lega leggera
 Attacco a vite 1" F
 2 ugelli Ø 6 e 7 mm
 Per irrigazione con piccola portata, a medie e basse
 pressioni

Made of brass and aluminium
 Screw connection 1" F
 2 nozzles Ø 6 e 7 mm
 Small discharge operating at low and medium pressures

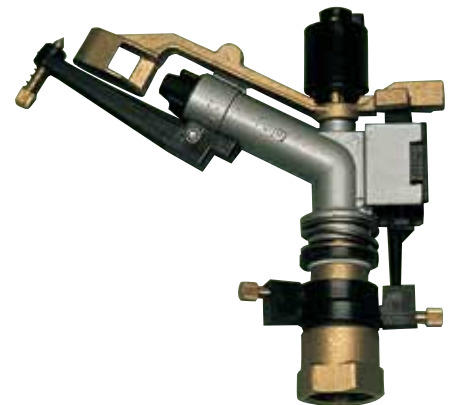

Ugello Ø mm	Press. atm.	Gittata m	Litri/sec	Sup. m ²
6	1,5	14,5	0,38	660
	2,-	15,-	0,44	706
	3,-	16,-	0,54	804
	4,-	17,-	0,63	907
7	1,5	15,-	0,62	706
	2,-	16,-	0,72	804
	3,-	17,-	0,88	907
	4,-	18,-	1,02	1077

50825





irrigatori a settori impulse sprinklers



mod. K1

Costruito in ottone e lega leggera.
Attacco 1.1/4" femmina.
3 ugelli Ø 8 - 9 - 10 mm
Per irrigazione con media portata.

Made off brass and aluminium
Screw connection 1.1/4" F
3 nozzles Ø 8 - 9 - 10 mm
Irrigation of medium discharge

Ugello Ø mm	Press. atm.	Gittata m	Litri/sec	Sup. m ²
8	1,5	15,-	0,83	707
	2,-	17,-	0,93	908
	3,-	19,5	1,14	1194
	4,-	22,-	1,31	1590
9	1,5	15,5	1,03	755
	2,-	17,5	1,19	962
	3,-	20,-	1,46	1256
	4,-	22,5	1,69	1590
10	2,-	18,5	1,48	1075
	2,5	20,-	1,65	1256
	3,-	21,5	1,81	1452
	3,5	23,-	1,96	1661

50827

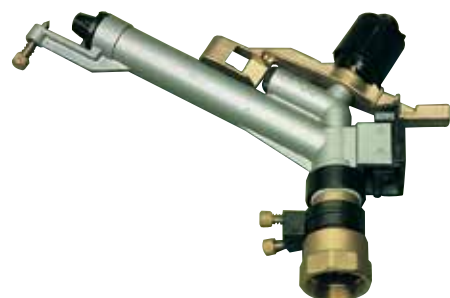

mod. AMBO

Costruito in ottone e lega leggera
Attacco a vite 1.1/2" F
3 ugelli Ø 10-12-14 mm
Ugello superiore 6 mm
Per irrigazione con media portata

Made off brass and aluminium
Screw connection 1.1/2" F
3 nozzles Ø 10-12-14 mm
Upper nozzle 6 mm

Ugello Ø mm	Press. atm.	Gittata m	Litri/sec	Sup. m ²
6/10	2,-	18,5	1,48	1075
	2,5	20,-	1,65	1256
	3,-	21,5	1,81	1452
	3,5	23,-	1,96	1661
6/12	2,-	20,-	2,14	1256
	2,5	21,5	2,39	1452
	3,-	23,-	2,62	1661
	3,5	24,5	2,83	1885
6/14	2,5	23,-	3,24	1661
	3,-	24,5	3,55	1885
	3,5	26,-	3,84	2123
	4,-	27,5	4,10	2375

50831



Treppiedi con fermi

In acciaio zincato ad altezza variabile

Stud bolts

Galvanized steel Variable height

50839	Att. 1/2" F	
50838	Att. 3/4" F	
50837	Att. 1" M	
50836	Att.1.1/4" M	
50835	Att. 1.1/2" M	



MAURER

Vite senza fine acciaio zincato
Nastro acciaio inox AISI 201

Galvanized screw
AISI 201 stainless steel band

	largh. / width mm	Ø mm	
• 87230	9	8x12	
• 86906	9	10x16	
• 86907	9	12x20	
• 86908	9	16x25	
• 86909	9	20x32	
• 86910	12	25x40	
• 86911	12	30x45	
• 86912	12	32x50	
• 86913	12	40x60	
• 86914	12	50x70	
• 86915	12	60x80	
• 87231	12	80x100	
• 87232	12	100x120	
• 87233	12	120x140	
• 87234	12	150x170	
• 87235	12	180x200	

MAURER

Vite senza fine acciaio inox AISI 304
Nastro acciaio inox AISI 304

AISI 304 stainless steel screw
AISI 304 stainless steel band

	largh. / width mm	Ø mm	
• 87236	9	8x12	
• 86916	9	10x16	
• 86917	9	12x20	
• 86918	9	16x25	
• 86919	9	20x32	
• 98749	12	16x25	
• 98750	12	20x32	
• 86920	12	25x40	
• 86921	12	30x45	
• 86922	12	32x50	
• 86923	12	40x60	
• 86924	12	50x70	
• 86925	12	60x80	
• 98694	12	70x90	
• 87237	12	80x100	
• 98695	12	90x110	
• 87238	12	100x120	
• 98696	12	110x130	
• 87239	12	120x140	
• 98697	12	140x160	
• 87240	12	150x170	
• 87241	13	180x200	



fascette stringitubo hose clamps

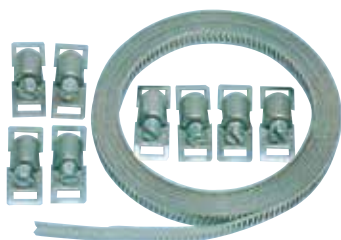

MAURER

Nastro per fascette

Nastro acciaio inox - lunghezza 3m
 Con 8 macchinette
 Larghezza 9 mm
 Ø di serraggio da 40 a 940 mm

Belt hose clamps
 Stainless steel belt - 3 m length
 With 8 tensioning clamps
 Width 9 mm
 Ø tightening: from 40 to 940 mm

• 83337



fascette cablaggio cable ties



MAURER

RIAPRIBILI - Nylon col. nero / Reusable - Nylon black

- 97675 200 x 7,6 mm 8 000071 976756
- 97676 300 x 7,6 mm 8 000071 976763

MAURER

Nylon colore nero / Nylon black colour

- 88497 100 x 2,5 mm 8 000071 884976
- 88498 135 x 2,5 mm 8 000071 884983
- 88499 160 x 2,5 mm 8 000071 884990
- 88500 200 x 2,5 mm 8 000071 885003
- 88501 140 x 3,5 mm 8 000071 885010
- 88502 200 x 3,5 mm 8 000071 885027
- 88503 280 x 3,5 mm 8 000071 885034
- 96855 370 x 3,6 mm 8 000071 968553
- 88504 200 x 4,5 mm 8 000071 885041
- 88505 280 x 4,5 mm 8 000071 885058
- 88506 360 x 4,5 mm 8 000071 885065
- 96856 450 x 4,8 mm 8 000071 968560
- 88507 280 x 7,5 mm 8 000071 885072
- 88509 360 x 7,5 mm 8 000071 885096
- 92038 450 x 7,5 mm 8 000071 920384
- 96857 540 x 7,8 mm 8 000071 968577
- 94857 610 x 9,0 mm 8 000071 948579
- 96858 780 x 9 mm 8 000071 968584

MAURER

Nylon colore naturale / Nylon natural colour

- 88483 100 x 2,5 mm 8 000071 884839
- 88484 135 x 2,5 mm 8 000071 884846
- 88485 160 x 2,5 mm 8 000071 884853
- 88486 200 x 2,5 mm 8 000071 884860
- 88487 140 x 3,5 mm 8 000071 884877
- 88488 200 x 3,5 mm 8 000071 884884
- 88489 280 x 3,5 mm 8 000071 884891
- 96851 370 x 3,6 mm 8 000071 968515
- 88490 200 x 4,5 mm 8 000071 884907
- 88491 280 x 4,5 mm 8 000071 884914
- 88492 360 x 4,5 mm 8 000071 884921
- 96852 450 x 4,8 mm 8 000071 968522
- 88493 280 x 7,5 mm 8 000071 884938
- 88495 360 x 7,5 mm 8 000071 884952
- 92037 450 x 7,5 mm 8 000071 920377
- 96853 540 x 7,8 mm 8 000071 968539
- 94856 610 x 9,0 mm 8 000071 948562
- 96854 780 x 9,0 mm 8 000071 968546
- 94969 650 x 12,6 mm 8 000071 949699
- 94970 1000 x 12,6 mm 8 000071 949705



MAURER

Nylon colore verde / Nylon green colour

• 95048	100 x 2,5 mm	8 000071 950480
• 95049	140 x 3,6 mm	8 000071 950497
• 95050	200 x 3,6 mm	8 000071 950503
• 95051	200 x 4,6 mm	8 000071 950510
• 95052	300 x 4,6 mm	8 000071 950527
• 95053	390 x 4,6 mm	8 000071 950534



brass hose connectors **raccordi in ottone**



Raccordi rapidi in ottone "Quick®" - Maschio	"Quick™" Brass hose connectors - Male
53873	1/2"
53874	3/4"
53875	1"



Raccordi rapidi in ottone "Quick®" - Femmina	"Quick™" Brass hose connectors - Female
53876	1/2"
53877	3/4"
53878	1"



Raccordi rapidi in ottone "Quick®" Con portagomma	"Quick™" Brass hose connectors With hose nozzle
53879	1/2" (12,5 mm)
53880	3/4" (19 mm)
53881	1" (25 mm)
Guarnizione in gomma antiolio / Rubber packings	
53882	

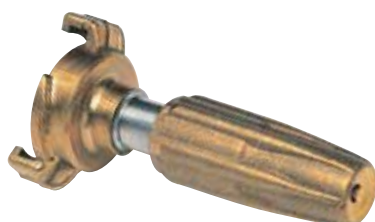

Lancia in ottone Con attacco rapido "Quick®" Getto regolabile	Brass hose nozzle "Quick™" connection Adjustable spray
54335	



raccordi connectors



Raccordi (3 pezzi) In plastica		Connectors (3 pcs) Plastic	
50943	Ø 13 mm	50947	Ø 25 mm
50944	Ø 15 mm	50948	Ø 30 mm
50945	Ø 18 mm	50950	Ø 35 mm
50946	Ø 20 mm	50951	Ø 40 mm
51644	Ø 22 mm	50952	Ø 50 mm



Derivazioni 3 vie "T" In plastica		"T" 3-way connectors Plastic	
50959	Ø 12 mm	50963	Ø 20 mm
50960	Ø 14 mm	50964	Ø 22 mm
50961	Ø 16 mm	50965	Ø 25 mm
50962	Ø 18 mm		



Raccordi continui In plastica / Plastic connectors			
50953	Ø 12/16 mm	50954	Ø 18/22 mm

raccordi in propilene propylene connectors



Manicotti / Couplings	
53888	Ø 20 mm
53889	Ø 25 mm
53890	Ø 32 mm
53891	Ø 40 mm



Raccordi maschio / Male adaptors	
53892	20 x 1/2" mm
53893	25 x 3/4" mm
53894	32 x 1" mm
53895	40 x 1,1/4" mm



Raccordi femmina / Female adaptors	
53896	20 x 1/2" mm
53897	25 x 3/4" mm
53898	32 x 1" mm
53899	40 x 1,1/4" mm



Tappi terminali / End plugs	
53900	Ø 20 mm
53901	Ø 25 mm
53902	Ø 32 mm
53903	Ø 40 mm



Raccordi a "T" a 90° / 90° Tee	
53904	Ø 20 mm
53905	Ø 25 mm
53906	Ø 32 mm
53907	Ø 40 mm



Raccordi a "T" a 90° con derivazione femmina / 90° Tee with female take off	
53908	20 x 1/2" mm
53909	25 x 3/4" mm
53910	32 x 1" mm
53911	40 x 1,1/4" mm



propylene connectors **raccordi in propilene**



Gomito a 90° / 90° elbow	
53912	Ø 20 mm
53913	Ø 25 mm
53914	Ø 32 mm
53915	Ø 40 mm



Gomito a 90° con derivazione - Maschio 90° Elbow with threaded off-take - Male	
53916	20 x 1/2" mm
53917	25 x 3/4" mm
53918	32 x 1" mm
53919	40 x 1,1/4" mm



Gomito a 90° con derivazione - Femmina 90° Elbow with threaded off-take - Female	
53920	20 x 1/2" mm
53921	25 x 3/4" mm
53922	32 x 1" mm
53923	40 x 1,1/4" mm

polyethylene black tube **tubo polietilene**

Tubo per irrigazione in polietilene / Polyethylene black tube for irrigation			
53885	Ø 20 mm	53886	Ø 32 mm
52422	Ø 25 mm	53887	Ø 40 mm



ball valves **valvole a sfera**



Valvole a sfera FF / Brass ball valves FF

• 87322	1/2" FF	
• 87323	3/4" FF	
• 87324	1" FF	
• 87325	1.1/4" FF	
• 87326	1.1/2" FF	
• 87327	2" FF	



Valvole a sfera MF / Brass ball valves MF

• 87331	1/2" MF	
• 87332	3/4" MF	
• 87333	1" MF	
• 87334	1.1/4" MF	
• 87335	1.1/2" MF	
• 87336	2" MF	



rubinetti taps



mod. DRAGON

In ottone finitura naturale
Attacco 1/2"

Cast brass natural finish
Inch 1/2"

• 55496



mod. DRAGON

In ottone finitura naturale
Chiusura a leva
Attacco 1/2"

Cast brass natural finish
With lever
Inch 1/2"

• 55497



In ottone finitura naturale
Con portagomma
Attacco 1/2"

Cast brass natural finish
With hose connector
Inch 1/2"

• 55495



In ottone finitura naturale
A pulsante
Attacco 1/2"

Cast brass natural finish
With push button
Inch 1/2"

• 99042



Rubinetti a sfera

In ottone sbiancato con portagomma

Ball taps
Made of brass, with hose connector

• 87337

poll. 1/2"



• 87338

poll. 3/4"



Aeratore rompigitto

Raccordo innesto rapido
Ottone cromato

Tap aerator
Quick connection
Brass chrome plated

• 98021

M24



• 98022

F22





mod. TIROLO

Fontana a muro

Ghisa colore antracite
 Finitura opaca
 Dimensioni: 45x25x80h cm
 Peso 21 Kg
 N.B. Fornita senza rubinetto

Wall fountain
 Cast iron charcoal colour
 Matt surface finish
 Measurement: 45x25x80h cm
 Weight 21 Kg
 N.B. Faucet not included

• 55493



mod. STUBAI

Fontana a muro

Ghisa colore antracite
 Finitura opaca
 Dimensioni: 35x26x54h cm
 Peso 15 Kg
 N.B. Fornita senza rubinetto

Wall fountain
 Cast iron charcoal colour
 Matt surface finish
 Measurement: 35x26x54h cm
 Weight 15 Kg
 N.B. Faucet not included

• 55494



mod. STIRIA

Fontana a pavimento

Ghisa colore antracite
 Finitura opaca
 Dimensioni: 45x41x114h cm
 Peso 65 Kg
 N.B. Fornita senza rubinetto

Floor fountain
 Cast iron charcoal colour
 Matt surface finish
 Measurement: 45x41x114h cm
 Weight 65 Kg
 N.B. Tap not included

• 55491



**mod. CARINZIA****Fontana a pavimento**

Ghisa colore antracite
 Finitura opaca
 Dimensioni: 43,5x43,5x104h cm
 Peso 32 Kg
 N.B. Fornita senza rubinetto

Floor fountain
 Cast iron charcoal colour
 Matt surface finish
 Measurement: 43,5x43,5x104h cm
 Weight 32 Kg
 N.B. Tap not included

• 55492

**mod. VORARLBERG****Fontana a pavimento**

Ghisa colore antracite
 Finitura opaca
 Dimensioni: 39x28,5x73h cm
 Peso 15 Kg
 N.B. Fornita senza rubinetto

Floor fountain
 Cast iron charcoal colour
 Matt surface finish
 Measurement: 39x28,5x73h cm
 Weight 15 Kg
 N.B. Tap not included

• 99041



Innaffiatoi in plastica / Watering plastic cans

51112	2 Litri	51114	9 Litri
51113	4 Litri	51115	12 Litri
54309	6 Litri	51116	16 Litri

**Taniche in plastica** / Plastic jerry cans

52129	3 Litri	51519	20 Litri
51516	5 Litri	51520	25 Litri
51517	10 Litri	52130	30 Litri
51518	15 Litri		

**Taniche in plastica con rubinetto** / Plastic jerry cans with tap

52131	10 Litri	51867	20 Litri
--------------	----------	--------------	----------





nebulizzatori pressure sprayer



mod. ZEFIRO

Nebulizzatore
1 litro
Colori assortiti

Pressure sprayer
1 litre
Various colors

87404



pompe irroratrici sprayers



mod. ALISEO

Pompa a pressione
Impugnatura anatomica, getto regolabile
Serbatoio materiale termoplastico, resistente ai raggi UV
Asta pompante Ø 32 mm

Precompression sprayer
Anatomical handle, adjustable nozzle
Thermoplastic tank, UV resistant
Piston Ø 32 mm

87405

2 Litri



CE



mod. LIBECCIO

Pompe spallabili
Lancia con impugnatura a leva, getto regolabile
Serbatoio materiale termoplastico, resistente ai raggi UV
Fascia laterale trasparente e graduata per il controllo del livello del liquido (ISO 19932 1-2)
Asta pompante in termoplastico Ø 50 mm
Valvola sicurezza e scarico pressione

Shoulder sprayers
Spray lance with lever handle, adjustable nozzle
Thermoplastic tank, UV resistant
Transparent and graduate lateral band for an easy checking of liquid level (ISO 19932 1-2)
Thermoplastic piston Ø 50 mm
Safety and pressure discharging valve

87406

6 lt



87407

8 lt





mod. SCIROCCO

Pompe a zaino

Lancia con impugnatura a leva, getto regolabile
 Serbatoio materiale termoplastico, resistente ai raggi UV
 Fascia laterale trasparente e graduata per il controllo del livello del liquido (ISO 19932 1-2)
 Funzionamento ambidestro
 Camera di compressione in materiale termoplastico
 Piedini con fissaggio a vite

Knapsack sprayers
 Spray lance with lever handle, adjustable nozzle
 Thermoplastic tank, UV resistant
 Transparent and graduate lateral band for an easy checking of liquid level (ISO 19932 1-2)
 Reversible left and right hand operation
 Thermoplastic compression chamber
 Feet fixed with screw

87408

12 lt



87409

16 lt



87434

20 lt



coperchio a tenuta ermetica



mod. GRECALE

Pompe a zaino

Pompante inox
 Lancia, impugnatura a rubinetto e getto regolabile in ottone
 Serbatoio materiale termoplastico, resistente ai raggi UV
 Fascia laterale trasparente e graduata per il controllo del livello del liquido (ISO 19932 1-2)
 Funzionamento ambidestro
 Camera di compressione in acciaio inox
 Piedini con fissaggio a vite

Knapsack sprayers
 Inox pump piston
 Spray lance, tap and adjustable nozzle in brass
 Thermoplastic tank, UV resistant
 Transparent and graduate lateral band for an easy checking of liquid level (ISO 19932 1-2)
 Reversible left and right hand operation
 Stainless steel compression chamber
 Feet fixed with screw

54404

12 lt



87433

16 lt



87410

20 lt



coperchio a tenuta ermetica

**papillon****mod. MAESTRALE****Pompa a zaino in rame**

Serbatoio rame

Pompante ottone

Lancia, impugnatura a rubinetto e getto regolabile in ottone

Copper knapsack sprayer

Copper container

Brass pump piston

Spray lance, tap and adjustable nozzle in brass

87411

16 lt

**papillon****mod. OSTRO****Pompa a zaino inox**

Serbatoio acciaio inox

Pompante acciaio inox

Lancia con impugnatura a leva, getto regolabile in ottone

Pompante a tenuta in ottone

Stainless steel sprayer

Stainless steel container

Stainless steel pump piston

Spray lance, tap and adjustable nozzle brass

Leak-proof chamber

92544

16 lt





POMPE PER LIQUIDI AGGRESSIVI - Specifiche per soluzioni acide, basiche, oli, grassi, idrocarburi, carburanti
PUMPS FOR AGGRESSIVE LIQUIDS - For acid and basic solutions, oils, greavers, hydrocarbons, motor fuels

papillon

mod. BORA

Pompa per liquidi aggressivi

Serbatoio in materiale plastico, polietilene riciclabile - Resistente ai raggi UV

Impugnatura anatomica, getto regolabile

Guarnizioni a tenuta speciale VITON®
 Fascia laterale trasparente e graduata per il controllo del livello del liquido (ISO 19932 1-2)

Asta pompante Ø 32 mm

Pump for aggressive liquids

Thermoplastic tank, UV resistant

Anatomical handle, adjustable nozzle

Special VITON® packings

Transparent and graduate lateral band for an easy checking of liquid level (ISO 19932 1-2)

Piston Ø 32 mm

89765

2 Litri



CE

Serbatoio in materiale plastico, polietilene riciclabile con trattamento anti UV

POMPE PER LIQUIDI AGGRESSIVI - Specifiche per soluzioni acide, basiche, oli, grassi, idrocarburi, carburanti
PUMPS FOR AGGRESSIVE LIQUIDS - For acid and basic solutions, oils, greavers, hydrocarbons, motor fuels

papillon

mod. MONSONE

Pompa per liquidi aggressivi

Serbatoio in materiale plastico, polietilene riciclabile - Resistente ai raggi UV

Valvola di sicurezza

Lancia con impugnatura a leva, getto regolabile

Guarnizioni a tenuta speciale VITON®

Fascia laterale trasparente e graduata per il controllo del livello del liquido (ISO 19932 1-2)

Asta pompante in termoplastico Ø 50 mm

Valvola sicurezza e scarico pressione

Pump for aggressive liquids

Thermoplastic tank, UV resistant

Safety valve

Spray lance with lever handle, adjustable nozzle

Special VITON® packings

Transparent and graduate lateral band for an easy checking of liquid level (ISO 19932 1-2)

Thermoplastic piston Ø 50 mm

Safety and pressure discharging valve

89766

6 Litri



CE



pompe irroratrici sprayers



Nebulizzatore / Sprayer

• 95465

1 Litro



8 000071 954655



Pompa a pressione / Precompression sprayer

• 95185

2 Litri



8 000071 951852



Pompa a pressione / Precompression sprayer

• 95186

6 Litri



8 000071 951869

• 95466

8 Litri



8 000071 954662



Pompe a zaino

Lancia in plastica con impugnatura a leva

Getto regolabile

Serbatoio materiale termoplastico,
resistente ai raggi UV

Camera di compressione in materiale
termoplastico

Knapsack sprayers

Plastic spray lance with lever handle

Adjustable nozzle

Thermoplastic tank, UV resistant

Thermoplastic compression chamber

• 95184

12 lt



8 000071 951845



Pompe a zaino

Lancia in plastica con impugnatura a leva
 Getto regolabile
 Serbatoio materiale termoplastico, resistente ai raggi UV
 Camera di compressione in materiale termoplastico

Knapsack sprayers
 Plastic spray lance with lever handle
 Adjustable nozzle
 Thermoplastic tank, UV resistant
 Thermoplastic compression chamber

• 95188

16 lt



Pompa a pressione / Precompression sprayer

• 97739

2 Litri



Pompa a pressione / Precompression sprayer

• 97740

6 Litri



POMPE PER LIQUIDI AGGRESSIVI - Specifiche per soluzioni acide, basiche, oli, grassi, idrocarburi, carburanti
PUMPS FOR AGGRESSIVE LIQUIDS - For acid and basic solutions, oils, greavers, hydrocarbons, motor fuels



pompe irroratrici sprayers

**Solfatrice a spalla**

Serbatoio materiale termoplastico

Capacità 5 Kg ca.

Completa di accessori

Esecuzione con leva destra o sinistra

Knapsack powder blower

Thermoplastic tank

Capacity 5 Kg ca.

With accessories

With right or left-handed lever

50975

8 000071 509756

**Soffietto per zolfo**

Senza tritratore

Capacità 800 gr

Atomizers

Without crusher

Capacity 800 gr

50976



RECINZIONI E COPERTURE



CATALOGO
GIARDINAGGIO
2017



sacco raccogli foglie garden bag



Sacco raccogli foglie e erba

Capacità 250 litri
Dimensioni: Ø 67 cm x H 75 cm
PP 150 g/m²

Garden bag for leaves
Capacity 250 liters
Measurement: Ø 67 cm x H 75 cm
PP 150 g/m²

• 97832



teli pacciamatura weed barrier mat



Teli multiuso per pacciamatura

Colore Nero
UV stabilizzato
Facile da usare
Permette al suolo di respirare e all'acqua di impregnare

Weed barrier mat
Black colour
UV stabilized
Easy to install
Allows soil to breathe and water to permeate

70 gr/m²

• 55519 0,91 x 10 m 8 000071 555197

• 55520 0,91 x 50 m 8 000071 555203

• 91967 1,05 x 100 m 8 000071 919678

• 91968 1,55 x 100 m 8 000071 919685

• 91969 2,05 x 100 m 8 000071 919692

100 gr/m²

Resistente al calpestio / Presenta righe colorate per facilitare l'allineamento di vasi e ortaggi

• 97833 1,05 x 100 m 8 000071 978330

• 97834 1,65 x 100 m 8 000071 978347

• 97835 2,05 x 100 m 8 000071 978354

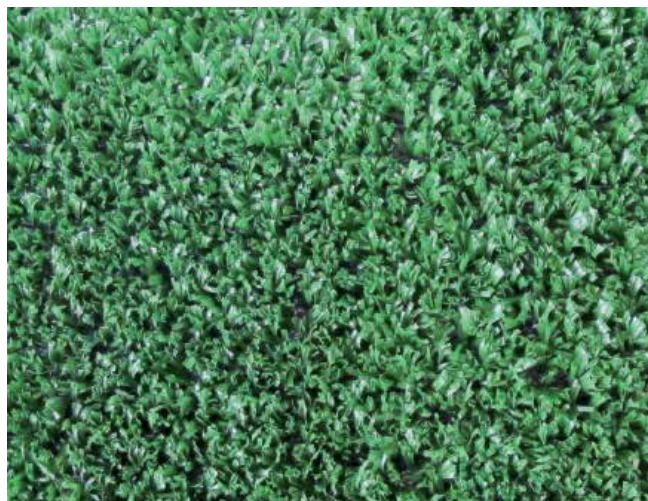

mod. GOLF

Prato sintetico in polipropilene
Monofilamento col. verde
Supporto in polipropilene+lattice
Stabilizzato UV
Altezza totale 10 mm

Artificial turf polypropylene
Mesh monofilament green
Baking polypropylene+latex
UV stabilized
Pile height 10 mm

• 55451	1 x 10 metri	 8 000071 554510
• 95043	1 x 25 metri	 8 000071 950435
• 94453	2 x 25 metri	 8 000071 944533



mod. CRICKET

Prato sintetico in polietilene
8 monofilamenti curvi
8 monofilamenti dritti
Colore verde bitono
Supporto in lattice
Stabilizzato raggi UV
Autoestinguente
Altezza totale 30 mm

Artificial turf polyethylene
8 straight monofilament
8 curled monofilament
Green bicolor
Baking latex
UV stabilized
Self-extinguishing
Pile height 30 mm

• 55453	1 x 5 metri	 8 000071 554534
• 94452	2 x 10 metri	 8 000071 944526



leaves fencing nets **siepi sintetiche a foglie**



mod. CHESTER

Sfere di bosso
Foglie in PVC verde
Lavabile e resistente ai raggi UV

Box ball
Fringe in PVC green colour
Washable and UV resistant

• 95402	Ø 28 cm	 8 000071 954020
• 94999	Ø 38 cm	 8 000071 949996
• 95000	Ø 55 cm	 8 000071 950008





siepi sintetiche a foglie leaves fencing nets



papillon		mod. ASCOT	
Schermatura totale	Full shielding		
Foglie lauro in tessuto plastificato	Plastified laurel leaves tissue		
Colore verde scuro	Dark green colour		
Sostenute da una rete in plastica a maglia quadra	Fencing net support, square mesh		
• 92555	1 x 3 metri		8 000071 925556
• 92556	1,5 x 3 metri		8 000071 925563
• 94450	1 x 20 metri		8 000071 944502



papillon		mod. LONGCHAMP	
Schermatura totale	Full shielding		
Foglie lauro in tessuto plastificato	Plastified laurel leaves tissue		
Colore verde scuro	Dark green colour		
Sostenute da una rete in plastica a maglia quadra con applicazione rete ombreggiante 80 gr/m ² sul retro	Fencing net support, square mesh with shanding net 80 gr/m ² on the back		
• 93132	1 x 3 metri		8 000071 931328
• 93133	1,5 x 3 metri		8 000071 931335
• 95001	1 x 20 metri		8 000071 950015



papillon		mod. SALISBURY	
Traliccio in legno estensibile, con foglie acero in tessuto plastificato	Foldable wood panel, with plastified maple leaves tissue		
Colore verde scuro	Dark green colour		
• 93138	1 x 2 metri		8 000071 931380



• 91189	1 x 100 m	
• 91190	1,5 x 100 m	
• 91191	2 x 100 m	
• 91192	3 x 100 m	
• 91193	4 x 100 m	
• 91194	6 x 100 m	

Rete tessuta in piattina, provvista di cimosa, con asole
 Ombreggiante ad alta schermatura (90%)
 Trama frangivista colore verde scuro
 Ideale per parcheggi, campeggi e terrazze

High screening woven net, in dark green colour.
 For shading and screening of parking places, camping, balconies

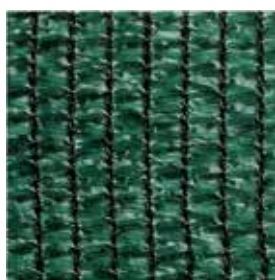

getpolyen fenced tarps **тели PVC multiuso retinati**



• 91897	3 x 1,5 m	
• 91898	3 x 1,9 m	
• 91899	3 x 2,5 m	
• 91900	3 x 3,0 m	
• 91901	3 x 4,0 m	
• 91902	3 x 5,0 m	
• 91903	3,5 x 1,5 m	
• 91904	3,5 x 1,9 m	
• 91905	3,5 x 2,5 m	
• 91906	3,5 x 3,0 m	
• 91907	3,5 x 4,0 m	
• 91908	3,5 x 5,0 m	



Per coperture esterne, tende balcone, rimessaggi, ecc.
 Col. Bianco trasparente
 Foglio laminato 140 gr/m² (+- 3%)
 UV stabilizzato
 Corda di rinforzo perimetrale
 Occhioli plastica ogni 25 cm sui 4 lati
 Resistente al vento, al gelo, impermeabile
 Facile da installare

For outside covers, balcony awning, depots etc.
 White transparent colour
 Laminated sheet 140 gr/m² (+- 3%)
 UV stabilized
 All four edges reinforced by rope plastic eyelets at every 25 cm
 Wind and snow proof, water proof
 Easy to install



teloni occhiellati p.e. tarpaulins



In polietilene a doppia laminazione
Resistente alle basse temperature
Trattamento contro i raggi U.V.
Impermeabile, lavabile, antistrappo
Robusti occhielli in policarbonato
Angoli rinforzati
Cordino di rinforzo perimetrale

P.E. laminated sheet
Low temperature resistant
U.V. treater
Waterproof, washable, antitear
Polycarbonate eyelets
Reinforced corners
Reinforced perimetrical wire

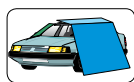

Per veicoli/Cars



Per autocarri e furgoni
Cars and trucks



Per barche/Boats



Per tende e campeggio
Tents and camping

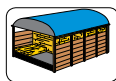

Per agricoltura
e stivaggi in genere
Agricultural purpose

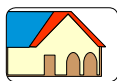

Per edilizia/Building

• 94745	2 x 2 m	110 gr/m ²	8 000071 947459
• 80361	2 x 3 m	110 gr/m ²	8 000071 803618
• 93269	3 x 3 m	110 gr/m ²	8 000071 932691
• 80210	3 x 4 m	110 gr/m ²	8 000071 802109
• 93270	3 x 5 m	110 gr/m ²	8 000071 932707
• 80211	4 x 4 m	110 gr/m ²	8 000071 802116
• 80212	4 x 5 m	110 gr/m ²	8 000071 802123
• 80213	4 x 6 m	110 gr/m ²	8 000071 802130
• 80381	5 x 6 m	110 gr/m ²	8 000071 803816
• 80214	6 x 8 m	110 gr/m ²	8 000071 802147
• 80215	6 x 10 m	130 gr/m ²	8 000071 802154
• 93271	8 x 10 m	130 gr/m ²	8 000071 932714
• 85945	8 x 12 m	130 gr/m ²	8 000071 859455
• 85946	10 x 12 m	130 gr/m ²	8 000071 859462



Idoneità contatto alimentare
UNI EN 1186-1:2003 / UNI EN 1186-3:2003



In polietilene a doppia laminazione
Resistente alle basse temperature (-40°C)
Trattamento con raggi U.V.
Impermeabile, lavabile, antistrappo
Robusti occhielli in policarbonato
Angoli rinforzati
Cordino di rinforzo perimetrale

P.E. laminated sheet
Low temperature resistant (-40°C)
U.V. treater
Waterproof, washable, antitear
Polycarbonate eyelets
Reinforced corners
Reinforced perimetrical wire



• 93792	2 x 3 m	200 gr/m ²	8 000071 937924
• 88184	3 x 4 m	200 gr/m ²	8 000071 881845
• 93793	4 x 4 m	200 gr/m ²	8 000071 937931
• 88185	4 x 5 m	200 gr/m ²	8 000071 881852
• 88186	4 x 6 m	200 gr/m ²	8 000071 881869
• 93794	5 x 6 m	200 gr/m ²	8 000071 937948
• 88187	6 x 8 m	200 gr/m ²	8 000071 881876
• 93795	6 x 10 m	200 gr/m ²	8 000071 937955
• 93796	8 x 12 m	200 gr/m ²	8 000071 937962

Tralicci plastica estensibili / PVC trellis		
Colore bianco / White colour		
• 83155	2 x 1 m	8 000071 831550
• 83156	3 x 1 m	8 000071 831567
• 83157	4 x 1 m	8 000071 831574
Colore verde / Green colour		
• 83158	2 x 1 m	8 000071 831581
• 83159	3 x 1 m	8 000071 831598
• 83160	4 x 1 m	8 000071 831604

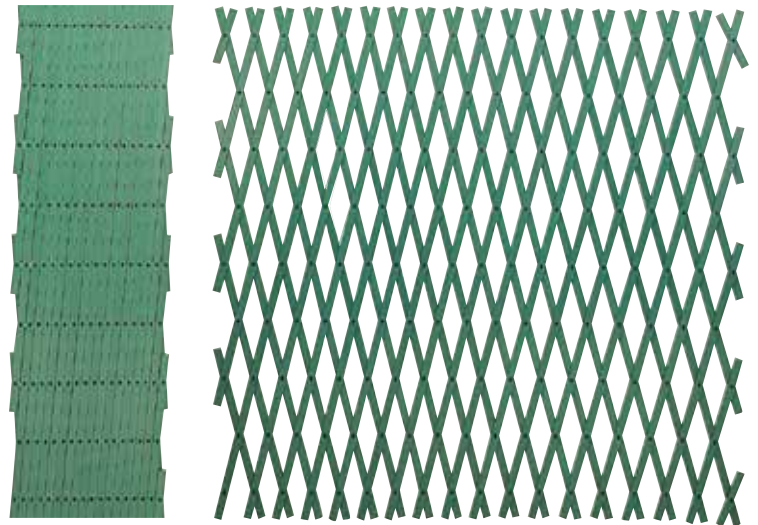

Supporto spirale Plastificato verde	Spiral plant support PVC green	
• 97144	175 cm	8 000071 971447

Prodotto conforme alla normativa RoHS
Complies with RoHS

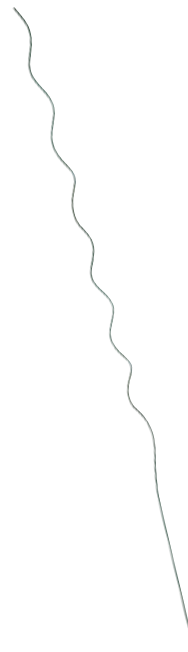
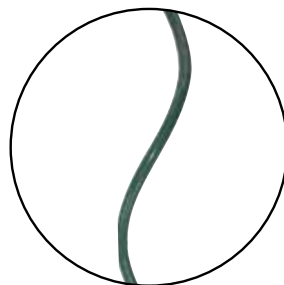

Confezioni 10 pezzi / 10 piece package		
81441	150 cm	ø 20/22 mm
81442	180 cm	ø 22/24 mm
81443	210 cm	ø 22/24 mm
81444	210 cm	ø 25/28 mm
54175	240 cm	ø 25/28 mm





rete sostegno piante netting support



Rete estrusa in polipropilene Flessibile, resistente, stabilizzata ai raggi UV. Maglia rettangolare 17x15 cm Colore verde	Extruded polypropylene net Flexible, strong, UV stabilised Rectangular mesh 17x15 cm Green colour
--	--

Confezione self service / Self-service packaging

• 91992	1,5 x 10 m	8 000071 919920
• 91993	2 x 10 m	8 000071 919937
Rotoli / Rolls		
• 95537	2,0 x 50 m	8 000071 955379
• 91994	1,5 x 100 m	8 000071 919944
• 91995	2 x 100 m	8 000071 919951

Prodotto conforme alla normativa RoHS / Complies with RoHS

reti balconi balconies net

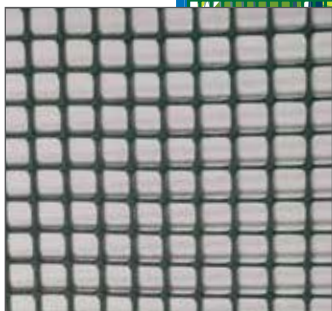

Rete estrusa in Polietilene ad alta densità HDPE Stabilizzata UV Maglia quadra 10x10 mm Cimosa laterale Altezza 1 metro Rotoli 50 metri	Extruded net in high density polyethylene HDPE UV stabilized Squared mesh 10x10 mm With reinforced edges Height 1 m Rolls 50 m
--	---

Colore / Colour

• 92002	Verde / Green	8 000071 920025
• 99216	Marrone / Brown	8 000071 992169
• 99217	Grigio antracite / Charcoal gray	8 000071 992176
• 99218	Bianco / White	8 000071 992183



Rete tessuta a trama doppia, resistente, indemagliabile
 Cimosa 4,5 cm
 Previene i danni alle colture
 Colore verde

Knitted net, double screen, ladder-proof
 4,5 cm edge list
 Protecting plants from hail damage.
 Green colour

Confezione self service / Self-service packaging

• 91982	2 x 5 m	8 000071 919821
• 91983	2 x 10 m	8 000071 919838
• 91984	4 x 10 m	8 000071 919845

Rotoli / Rolls

• 91977	1,5 x 100 m	8 000071 919777
• 91978	2 x 100 m	8 000071 919784
• 91979	3 x 100 m	8 000071 919791
• 91980	4 x 100 m	8 000071 919807
• 91981	6 x 100 m	8 000071 919814

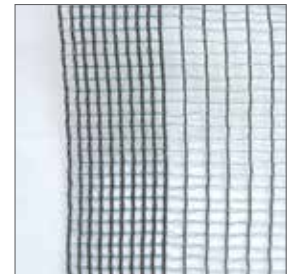

Dettaglio maglia e cimosa / detail mesh and selvedge



Rete estrusa in polipropilene
 Flessibile, resistente
 Stabilizzata ai raggi UV
 Colore verde
 Maglia 15x15 mm

Extruded polypropylene net
 Flexible, strong
 UV stabilised.
 Green colour
 Mesh 15x15 mm

Confezione self service / Self-service packaging

• 91996	2 x 5 m	8 000071 919968
• 95538	4 x 5 m	8 000071 955386
• 91997	2 x 10 m	8 000071 919975
• 95539	4 x 12 m	8 000071 955393



Prodotto conforme alla normativa RoHS / Complies with RoHS



reti raccolta olive olive nets

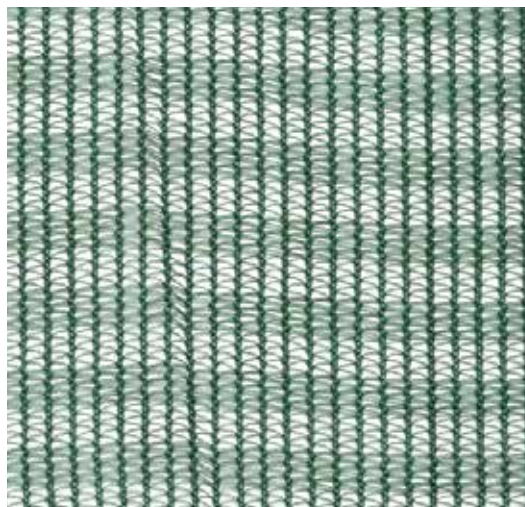

Teli senza apertura centrale
Sheet without central opening

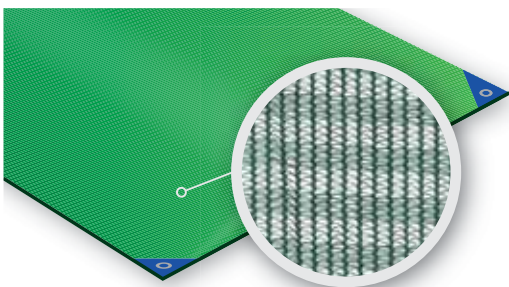

Teli con apertura centrale
Sheet with central opening

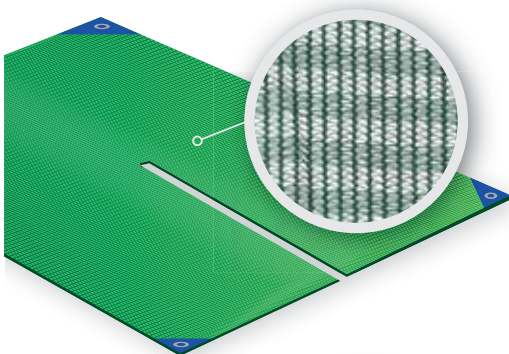

Monofilamento 100% HDPE 100% HDPE monofilament yarn
 Colore Verde Green colour
 Angoli rinforzati, con occhielli Reinforced corners, with grommets
 Stabilizzata UV, con cimose sui lati UV stabilised, edge list

Teli senza apertura centrale / Sheet without central opening

• 94112	3 x 6 m	8 000071 941129
• 93746	4 x 8 m	8 000071 937467
• 93747	5 x 10 m	8 000071 937474
• 93748	5 x 12 m	8 000071 937481
• 93749	6 x 8 m	8 000071 937498
• 93750	6 x 12 m	8 000071 937504
• 93751	8 x 10 m	8 000071 937511
• 93752	8 x 12 m	8 000071 937528

Teli con apertura centrale / Sheet with central opening

• 93753	6 x 6 m	8 000071 937535
• 93762	6 x 8 m	8 000071 937627
• 93754	8 x 8 m	8 000071 937542
• 93755	10 x 10 m	8 000071 937559
• 93756	12 x 12 m	8 000071 937566

Rotoli / Rolls

• 93757	5 x 50 m	8 000071 937573
• 93758	6 x 50 m	8 000071 937580
• 93759	7 x 50 m	8 000071 937597
• 94108	8 x 50 m	8 000071 941082
• 94109	10 x 50 m	8 000071 941099
• 93760	4 x 100 m	8 000071 937603
• 93761	6 x 100 m	8 000071 937610
• 94110	7 x 100 m	8 000071 941105
• 94111	8 x 100 m	8 000071 941112



Montaggio rapido senza bisogno di utensili
Copertura frontale avvolgibile con cerniere
Copertura in PVC trasparente

Easy assembly in minutes, without tools
Roll-up zipped panels for easy access
Clear PVC covers

	L x P x H	ripiani / shelves	
• 94287	69x49x125 cm	3	
• 94288	69x49x157 cm	4	
• 94289	69x49x187 cm	5	

Telo PVC per copertura serra / PVC cover for greenhouse

• 94596	69x49x125 cm	
• 94597	69x49x157 cm	
• 94598	69x49x187 cm	

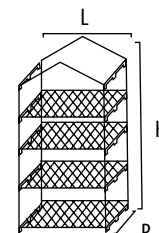

Montaggio rapido senza bisogno di utensili
Copertura frontale avvolgibile con cerniere
Copertura in PVC trasparente

Easy assembly in minutes, without tools
Roll-up zipped panels for easy access
Clear PVC covers

	L x P x H	ripiani / shelves	
• 94290	140x72x195 cm	4	

Telo PVC per copertura serra / PVC cover for greenhouse

• 94599	140x72x195 cm	
----------------	---------------	--

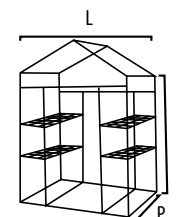

Serra tunnel in kit

Per proteggere colture ed ortaggi Kit

Completo di:

6 tubi in plastica con 3 raccordi per costruire archetti

Film neutro (2x5 m) stabilizzato UV

9 clips ferma telo + 2 chiodi a U per il fermo delle estremità

Tunnel greenhouse kit

Vegetables and coltures protection

6 plastic tubes with 3 connectors

Neutral canvas (2x5 m) UVA resistant

9 clips + 3 pegs

54174	3 x 1,2 m	
--------------	-----------	--





teli protezione in tnt non-woven fabric



TELI TNT

Tessuto non tessuto in fibra di polipropilene
 Leggero, permeabile all'acqua, all'aria
 e alla luce
 Protegge dal freddo, vento, insetti e volatili
 17 gr/m²

Lightweight spun bonded polypropylene fleece
 Permeable to water, light and air
 Protects plants and vegetables from cold, wind,
 insect and birds
 17 gr/m²

Confezione self service / Self-service packaging

• 53943

1,5 x 10 m



• 55522

1,5 x 5 m



• 54220

2 x 10 m



• 55524

2,4 x 10 m



Rotoli / Rolls

• 54621

1,6 x 250 m



CAPPUCCI TNT

Cappucci in tessuto non tessuto in
 polipropilene
 Per la protezione di piante e arbusti di colore
 bianco, leggero, permeabile all'acqua,
 all'aria e alla luce
 Protegge piante e piccoli arbusti dal freddo,
 vento e dagli sbalzi climatici
 17 gr/m²

Non-woven fabric cups in PP material
 Provides protection for plants and shrubbery
 Permeable to water, light and air
 Protect plants and shrubbery from cold, wind and
 weather changes
 17 gr/m²

• 94144

Ø 0,6 x 0,8 m

6 pz / pcs



• 94145

Ø 1,6 x 1 m

3 pz / pcs



• 94146

Ø 1,6 x 2 m

1 pz / pcs



<p>Prodotto assolutamente naturale, già concimato e pronto per l'uso. Costituito da una miscela equilibrata di torba, sostanze organiche animali e vegetali.</p>		<p>Natural product, manured and ready for use. Compound with well-balanced mixture of peat, vegetal and animal organic substances.</p>	
53689	10 litri		
53690	20 litri		
53691	50 litri		
53925	80 litri		



Clips e chiodi in plastica per l'installazione di reti, tessuti, film

Range of clips and netting pegs for installation of nets, meshes.

Chiodi U fissa telo / U nails

• 97142 20 pz / pcs



Clips

• 91986 35 mm 24 pz / pcs 

• 91987 35 mm 100 pz / pcs 

• 91988 50 mm 100 pz / pcs 

Chiodi / Pegs

54626 24 pz / pcs

54627 500 pz / pcs

Ganci supporto in metallo / Metal hooks

54966 50 pz / pcs





reti metalliche metal networks



mod. CORRAL

Rete zincata a caldo elettrosaldada con ottima resistenza alla trazione e lunga durata di vita

Hot dipped galvanized electric welded mesh, are made of low carbon steel at high industrial standard, with strong tensile strength and long working life

Uso / Use

Recinzione per gabbie animali
Animals cages pen



Rivestimento zinco / Zinc coating

200 gr/m² ca.

Carico di rottura / Tensile strength

500-600 N/mm²





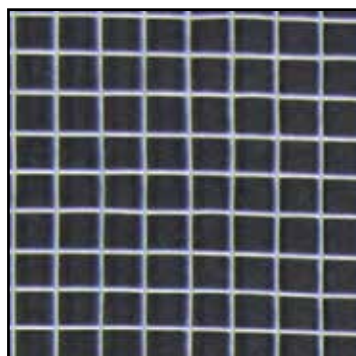









	maglia / mesh mm	ø filo / wire mm	H cm	L m	Kg ca.	
• 89902	12,7 x 12,7	1,05	51	10	5,0	8 000071 899024
• 89903	12,7 x 12,7	1,05	61	10	6,0	8 000071 899031
• 89904	12,7 x 12,7	1,05	81	10	8,0	8 000071 899048
• 89905	12,7 x 12,7	1,05	102	10	9,5	8 000071 899055
• 89267	6,3 x 6,3	0,55	50	25	7,4	8 000071 892674
• 89268	6,3 x 6,3	0,55	100	25	14,7	8 000071 892681
• 89269	12,7 x 12,7	0,80	100	25	15,0	8 000071 892698
• 89270	12,7 x 12,7	1,05	51	25	12,0	8 000071 892704
• 89271	12,7 x 12,7	1,05	61	25	14,5	8 000071 892711
• 89272	12,7 x 12,7	1,05	81	25	19,2	8 000071 892728
• 89273	12,7 x 12,7	1,05	102	25	24,2	8 000071 892735
• 89274	12,7 x 25,4	1,45	51	25	18,0	8 000071 892742
• 89275	12,7 x 25,4	1,45	61	25	21,7	8 000071 892759
• 89276	12,7 x 25,4	1,45	81	25	28,8	8 000071 892766
• 89277	12,7 x 25,4	1,45	102	25	36,5	8 000071 892773
• 89278	16,0 x 16,0	1,20	61	25	16,0	8 000071 892780
• 89279	16,0 x 16,0	1,20	102	25	27,0	8 000071 892797
• 93678	19,0 x 19,0	1,45	61	25	19,3	8 000071 936781
• 93679	19,0 x 19,0	1,45	81	25	25,6	8 000071 936798
• 89280	19,0 x 19,0	1,45	101	25	32,0	8 000071 892803





mod. CORRAL PLAST

	maglia / mesh mm	ø filo / wire mm	H cm	L m	 Kg ca.	
• 89906	12,7 x 12,7	0,90	50	10	2,3	
• 89907	12,7 x 12,7	0,90	60	10	2,8	
• 89908	12,7 x 12,7	0,90	80	10	3,7	
• 89909	12,7 x 12,7	0,90	100	10	4,6	
• 89281	12,7 x 12,7	0,90	50	25	5,5	
• 89759	12,7 x 12,7	0,90	60	25	7,0	
• 89760	12,7 x 12,7	0,90	80	25	9,3	
• 89282	12,7 x 12,7	0,90	100	25	11,0	
• 89761	12,7 x 12,7	0,90	120	25	14,0	
• 89283	12,7 x 12,7	0,90	150	25	16,5	
• 89284	12,7 x 12,7	0,90	200	25	22,0	

Rete zincata elettrosaldata rivestita in PVC resistente alla corrosione. Il rivestimento in PVC ha una buona stabilità di colore, resistenza all'invecchiamento e all'azione dei raggi UV.

It is welded by electro galvanized mild steel wire, then the mesh is through a corrosion resistant plastic coating finish, by which it is double protected. The PVC coating is proved anti-fatigue with a high colour stability and UV resistant.

Uso / Use

Recinzione per voliere e abitazioni
Aviary, residences enclosure



Rivestimento zinco / Zinc coating

25 gr/m² ca.

Rivestimento PVC / PVC coating

0,4 - 0,5 mm - col. Verde

Carico di rottura / Tensile strength

450 N/mm²

Rivestimento PVC colore verde conforme alla normativa RoHs

Coating complies with RoHs

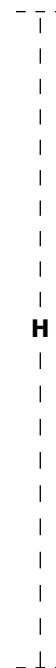
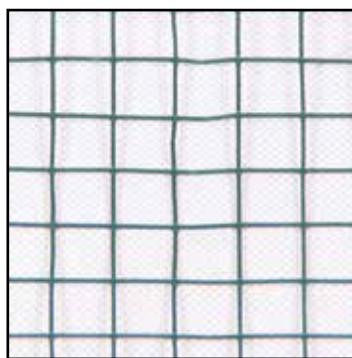



mod. FARM

Rete zincata a caldo a maglia esagonale tripla torsione

Triple twist hexagonal wire netting, hot dipped galvanized after wove

Uso / Use

Recinzione per piccoli animali
Little animals enclosure



Rivestimento zinco / Zinc coating

200 gr/m² ca.

Carico di rottura / Tensile strength

500-600 N/mm²



	maglia / mesh mm x N	ø filo / wire mm	H cm	L m	Kg ca.	
• 89910	13 x 2	0,70	100	10	5,0	
• 89911	16 x 2	0,70	50	10	3,0	
• 89912	16 x 2	0,70	100	10	4,3	
• 89913	20 x 2	0,70	100	10	4,0	
• 89285	13 x 2	0,70	100	25	12,5	
• 89286	16 x 2	0,70	50	25	5,4	
• 89287	16 x 2	0,70	100	25	10,8	
• 89288	20 x 2	0,70	100	25	8,6	
• 89289	25 x 3	0,80	100	25	8,6	
• 89290	25 x 3	0,80	200	25	17,3	
• 89291	50 x 4	0,90	100	25	5,8	
• 89292	50 x 4	0,90	150	25	8,6	
• 90837	50 x 7	1,20	100	25	10,5	
• 90838	50 x 7	1,20	150	25	15,7	
• 91341	50 x 7	1,20	200	25	21,0	

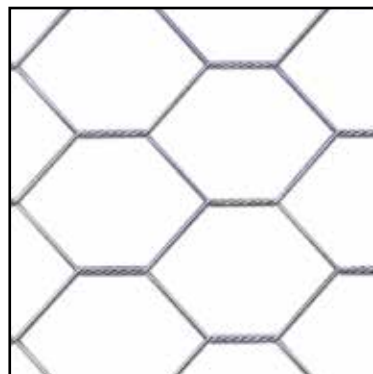



mod. CAPITOL

	maglia / mesh mm	ø filo / wire mm		H cm	L m	Kg ca.	Barcode
		zinc.	plast.				
• 91440	50,8 x 50,8	2,45	2,95	102	25	42,0	8 000071 914406
• 91441	50,8 x 50,8	2,45	2,95	122	25	51,0	8 000071 914413
• 91442	50,8 x 50,8	2,45	2,95	150 *	25	63,0	8 000071 914420
• 91443	50,8 x 50,8	2,45	2,95	180 *	25	45,3	8 000071 914437
• 91444	50,8 x 50,8	2,45	2,95	201 *	25	83,6	8 000071 914444

Rete zincata rivestita in PVC resistente alla corrosione. Il rivestimento in PVC ha una buona stabilità di colore, resistenza all'invecchiamento e all'azione dei raggi UV.

It is welded by electro galvanized mild steel wire, then the mesh is through a corrosion resistant plastic coating finish, by wich it is double protected. The PVC coating is proved anti-fatigue with a high colour stability and UV resistant.

Uso / Use

Recinzione per abitazioni
Residences enclosure



Rivestimento zinco / Zinc coating

25 gr/m² ca.

Rivestimento PVC / PVC coating

0,4 -0,5 mm - col. Verde

Carico di rottura / Tensile strength

450 N/mm²

Rivestimento PVC colore verde conforme alla normativa RoHs

Coating complies with RoHs

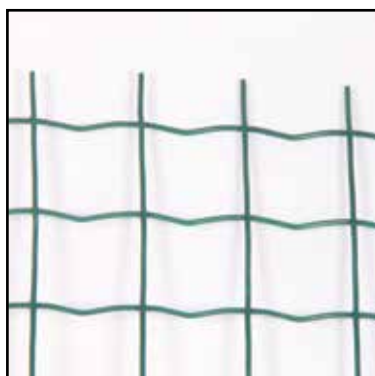
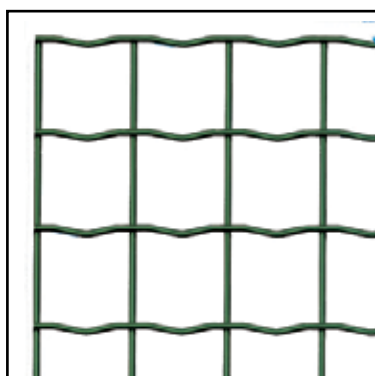

filo sporgente nella parte alta e bassa della rete (H 150 - 180 - 201)

putting-out wire at the top of net (H 150 - 180 - 201)

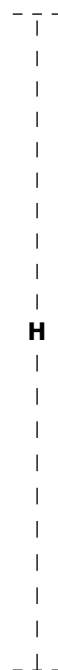



mod. RESERVE

	maglia / mesh mm	ø filo / wire mm orizzontale		ø filo / wire mm verticale		H cm	L m	Kg ca.	Barcode
		zinc.	plast.	zinc.	plast.				
• 91445	50,8 x 50,8	2,0	2,5	1,8	2,2	102	25	25,7	8 000071 914451
• 91446	50,8 x 50,8	2,0	2,5	1,8	2,2	122	25	30,4	8 000071 914468
• 91447	50,8 x 50,8	2,0	2,5	1,8	2,2	152	25	38,0	8 000071 914475
• 91448	50,8 x 50,8	2,0	2,5	1,8	2,2	183	25	45,6	8 000071 914482
• 91449	50,8 x 50,8	2,0	2,5	1,8	2,2	203	25	50,4	8 000071 914499

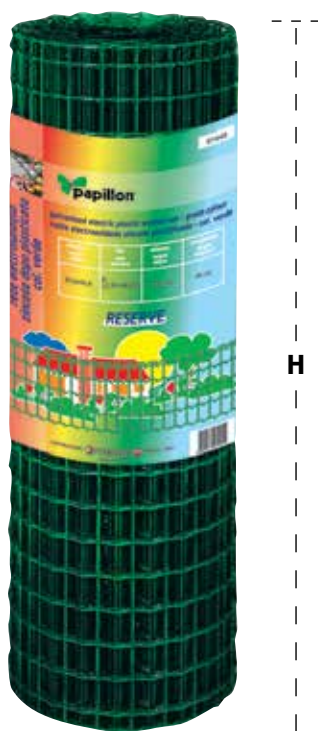

Rete zincata elettrosaldata, rivestita con finitura in PVC resistente alla corrosione. Il rivestimento in PVC ha una buona stabilità di colore, resistenza all'invecchiamento e all'azione dei raggi UV. Rinforzata nella parte alta e bassa della rete.

It is welded by electro galvanized mild steel wire, then the mesh is through a corrosion resistant plastic coating finish, by which it is double protected. The PVC coating is proved anti-fatigue with a high colour stability and UV resistant.

Net reinforced at the top and bottom.

Uso / Use

Recinzione per abitazioni
Residences enclosure



Rivestimento zinco / Zinc coating

25 gr/m² ca.

Rivestimento PVC / PVC coating

0,4-0,5 mm - col. Verde

Carico di rottura / Tensile strength

450 N/mm²

Rivestimento PVC colore verde conforme alla normativa RoHS

Coating complies with RoHS

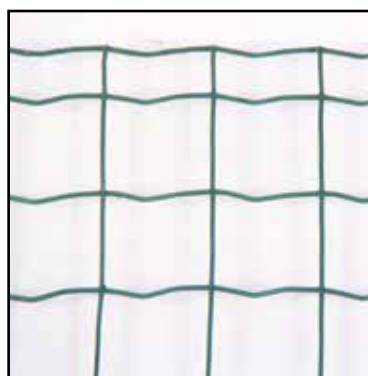



mod. COUNTRY

	maglia / mesh mm	ø filo / wire mm		H cm	L m	Kg ca.	Barcode
		zinc.	plast.				
• 91457	101,6 x 50,8	2,00	2,50	61	10	8,5	8 000071 914574
• 91458	101,6 x 50,8	2,00	2,50	81	10	7,7	8 000071 914581
• 91459	101,6 x 50,8	2,00	2,50	102	10	9,2	8 000071 914598
• 91460	101,6 x 50,8	2,00	2,50	122	10	11,0	8 000071 914604
• 92066	101,6 x 50,8	2,00	2,50	152	10	13,8	8 000071 920667
• 92067	101,6 x 50,8	2,00	2,50	183	10	16,6	8 000071 920674
• 92068	101,6 x 50,8	2,00	2,50	203	10	18,4	8 000071 920681
• 91450	101,6 x 50,8	2,00	2,50	61	25	14,5	8 000071 914505
• 91451	101,6 x 50,8	2,00	2,50	81	25	19,4	8 000071 914512
• 91452	101,6 x 50,8	2,00	2,50	102	25	23,7	8 000071 914529
• 91453	101,6 x 50,8	2,00	2,50	122	25	28,0	8 000071 914536
• 91454	101,6 x 50,8	2,00	2,50	152	25	34,5	8 000071 914543
• 91455	101,6 x 50,8	2,00	2,50	183	25	41,5	8 000071 914550
• 91456	101,6 x 50,8	2,00	2,50	203	25	46,0	8 000071 914567

Rete zincata elettrosaldata, rivestita con finitura in PVC resistente alla corrosione. Il rivestimento in PVC ha una buona stabilità di colore, resistenza all'invecchiamento e all'azione dei raggi UV.

Rinforzata nella parte alta e bassa della rete.

It is welded by electro galvanized mild steel wire, then the mesh is through a corrosion resistant plastic coating finish, by which it is double protected. The PVC coating is proved anti-fatigue with a high colour stability and UV resistant.

Net reinforced at the top and bottom.

Uso / Use

Recinzione per abitazioni
Residences enclosure



Rivestimento zinco / Zinc coating

25 gr/m² ca.

Rivestimento PVC / PVC coating

0,4-0,5 mm - col. Verde

Carico di rottura / Tensile strength

450 N/mm²

Rivestimento PVC colore verde conforme alla normativa RoHS

Coating complies with RoHS

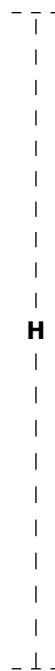
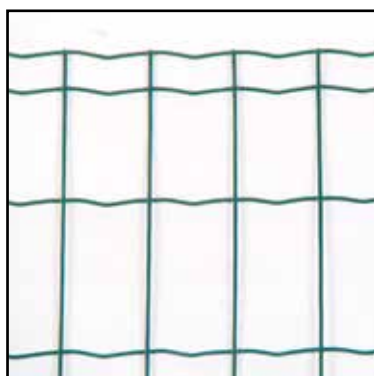



mod. YARD

Rete zincata elettrosaldada, rivestita con finitura PVC resistente alla corrosione. Il rivestimento in PVC ha una buona stabilità di colore, resistenza all'invecchiamento e all'azione dei raggi UV.

Rinforzata nella parte alta e bassa della rete.

It is welded by electro galvanized mild steel wire, then the mesh is through a corrosion resistant plastic coating finish, by wich it is double protected. The PVC coating is proved anti-fatigue with a high colour stability and UV resistant. Net reinforced at the top and bottom.

Usò / Use

Recinzione per abitazioni
Residences enclosure



Rivestimento zinco / Zinc coating

25 gr/m² ca.

Rivestimento PVC / PVC coating

0,4-0,5 mm - col. Verde

Carico di rottura / Tensile strength

450 N/mm²

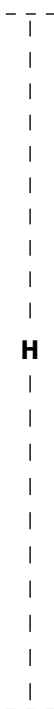

	maglia / mesh mm	ø filo / wire mm		H cm	L m	Kg ca.	Barcode
		zinc.	plast.				
• 93681	76,2 x 63,5	1,80	2,20	61	10	4,4	8 000071 936811
• 93682	76,2 x 63,5	1,80	2,20	81	10	5,8	8 000071 936828
• 93683	76,2 x 63,5	1,80	2,20	104	10	7,4	8 000071 936835
• 93684	76,2 x 63,5	1,80	2,20	119	10	8,8	8 000071 936842
• 93685	76,2 x 63,5	1,80	2,20	150	10	10,8	8 000071 936859
• 93686	76,2 x 63,5	1,80	2,20	180	10	13,2	8 000071 936866
• 93687	76,2 x 63,5	1,80	2,20	203	10	14,8	8 000071 936873
• 91461	76,2 x 63,5	1,80	2,20	81	25	14,7	8 000071 914611
• 91462	76,2 x 63,5	1,80	2,20	104	25	18,6	8 000071 914628
• 91463	76,2 x 63,5	1,80	2,20	119	25	22,0	8 000071 914635
• 91464	76,2 x 63,5	1,80	2,20	150	25	27,0	8 000071 914642
• 91465	76,2 x 63,5	1,80	2,20	180	25	33,0	8 000071 914659
• 91466	76,2 x 63,5	1,80	2,20	203	25	37,0	8 000071 914666

Rivestimento PVC colore verde conforme alla normativa RoHS

Coating complies with RoHS

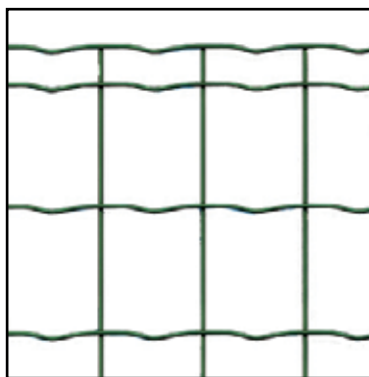



mod. RELEASE

	maglia / mesh mm	ø filo / wire mm		H cm	L m	Kg ca.	Barcode
		zinc.	plast.				
• 94758	76,2 X 63,5	1,55	2,0	60	25	7,9	8 000071 947589
• 94759	76,2 X 63,5	1,55	2,0	80	25	10,7	8 000071 947596
• 94760	76,2 X 63,5	1,55	2,0	100	25	12,8	8 000071 947602
• 94761	76,2 X 63,5	1,55	2,0	125	25	15,6	8 000071 947619
• 94762	76,2 X 63,5	1,55	2,0	150	25	19,5	8 000071 947626
• 94763	76,2 X 63,5	1,55	2,0	180	25	23,4	8 000071 947633
• 94764	76,2 X 63,5	1,55	2,0	200	25	25,5	8 000071 947640
• 94765	76,2 X 63,5	1,55	2,0	60	10	3,1	8 000071 947657
• 94766	76,2 X 63,5	1,55	2,0	80	10	4,3	8 000071 947664
• 94767	76,2 X 63,5	1,55	2,0	100	10	5,1	8 000071 947671
• 94768	76,2 X 63,5	1,55	2,0	125	10	6,2	8 000071 947688
• 94769	76,2 X 63,5	1,55	2,0	150	10	7,8	8 000071 947695
• 94770	76,2 X 63,5	1,55	2,0	180	10	9,4	8 000071 947701
• 94771	76,2 X 63,5	1,55	2,0	200	10	10,2	8 000071 947718

Rete zincata elettrosaldada, rivestita con finitura in PVC resistente alla corrosione. Il rivestimento in PVC ha una buona stabilità di colore, resistenza all'invecchiamento e all'azione dei raggi UV.

It is welded by electro galvanized mild steel wire, then the mesh is through a corrosion resistant plastic coating finish, by which it is double protected. The PVC coating is proved anti-fatigue with a high colour stability and UV resistant.

Uso / Use

Recinzione per abitazioni
Residences enclosure



Rivestimento zinco / Zinc coating

25 gr/m² ca.

Rivestimento PVC / PVC coating

0,4-0,5 mm - col. Verde

Carico di rottura / Tensile strength

450 N/mm²

Rivestimento PVC colore verde conforme alla normativa RoHs

Coating complies with RoHs

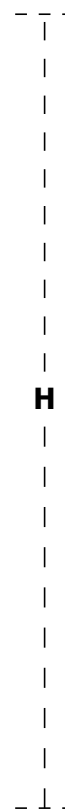
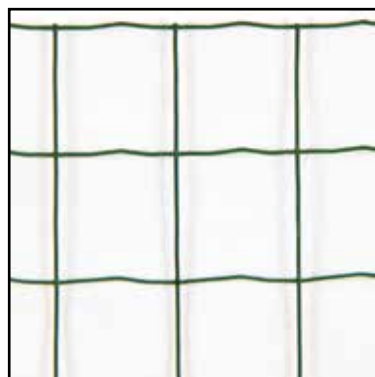



mod. RESIDENCE

	maglia / mesh mm	ø filo / wire mm orizzontale		ø filo / wire mm verticale		H cm	L m	Kg ca.	Barcode
		zinc.	plast.	zinc.	plast.				
• 91476	150 x 90	1,55	2,4	2,45	3,25	40	10	4,0	8 000071 914765
• 91477	150 x 90	1,55	2,4	2,45	3,25	65	10	5,5	8 000071 914772
• 91472	150 x 90	1,55	2,4	2,45	3,25	40	25	9,8	8 000071 914727
• 91473	150 x 90	1,55	2,4	2,45	3,25	65	25	13,5	8 000071 914734
• 91474	150 x 90	1,55	2,4	2,45	3,25	90	25	17,9	8 000071 914741
• 91475	150 x 90	1,55	2,4	2,45	3,25	120	25	21,6	8 000071 914758

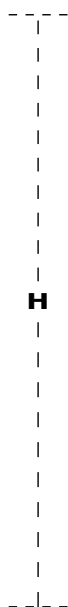

Rete zincata a maglia intrecciata, rivestita con finitura in PVC resistente alla corrosione. Il rivestimento in PVC ha una buona stabilità di colore, resistenza all'invecchiamento e all'azione dei raggi UV.

It is made of plastic coated steel wire, then wire galvanized before coated, then woven to mesh. It has a high colour stability and UV resistant. raw PVC are proved anti-fatigue under laboratory test.

Uso / Use

Recinzione per abitazioni, aiuole
Residences, flower-beds enclosure



Rivestimento zinco / Zinc coating

25 gr/m² ca.

Rivestimento PVC / PVC coating

0,8-0,9 mm - col. Verde

Carico di rottura / Tensile strength

500-550 N/mm²





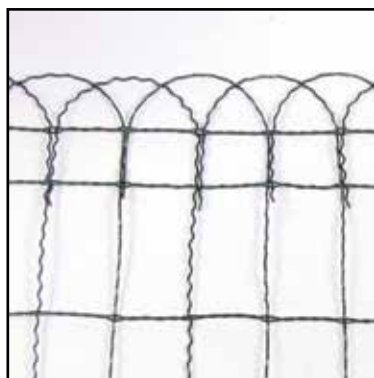





Rivestimento PVC colore verde conforme alla normativa RoHS

Coating complies with RoHS





mod. ENCLOSE

	maglia / mesh mm	ø filo / wire mm	H cm	L m	 Kg ca.	
• 93688	50 x 25	1,80	100	25	29,5	
• 93689	50 x 25	1,80	120	25	36,0	
• 93690	50 x 25	1,80	150	25	44,9	
• 93691	50 x 25	1,80	180	25	54,0	
• 93692	50 x 25	1,80	200	25	59,0	
• 92061	75 x 50	1,80	100	25	14,6	
• 92062	75 x 50	1,80	120	25	17,8	
• 92063	75 x 50	1,80	150	25	22,2	
• 92064	75 x 50	1,80	180	25	26,8	
• 92065	75 x 50	1,80	200	25	29,2	

Rete zincata a caldo elettrosaldata, con buona resistenza alla trazione. Si adatta bene alle esigenze di qualsiasi recinzione e protezione.

Made of hot dipped gavanized low carbon steel electric welded wire, with strong tensile strength, works well for every performance.

Uso / Use

Recinzione per abitazioni, animali
Residences, animals



Rivestimento zinco / Zinc coating

50 gr/m² ca.

Carico di rottura / Tensile strength

500-550 N/mm²

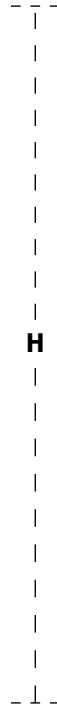
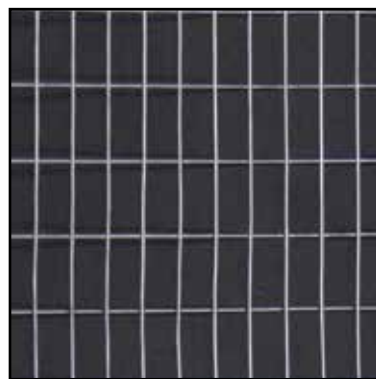



reti metalliche metal networks



mod. ENCLOSE PLAST

Rete zincata elettrosaldata, rivestita con finitura in PVC resistente alla corrosione. Il rivestimento in PVC ha una buona stabilità di colore, ed è resistente ai raggi UV.

It is welded by electro galvanized mild steel wire, then whole mesh through a corrosion resistant plastic coated finish. The superior mesh is then double protected. The PVC coating is proved anti-fatigue with a high colour stability and UV resistant.

Uso / Use

Recinzione per abitazioni, animali
Residences, animals



Rivestimento zinco / Zinc coating

20-25 gr/m² ca.

Rivestimento PVC / PVC coating

0,35 - 0,4 mm - col. Verde

Carico di rottura / Tensile strength

500-550 N/mm²

	maglia / mesh mm	ø filo / wire mm		H cm	L m	Kg ca.	Barcode
		zinc.	plast.				
• 92912	75 X 50	1,80	2,15	100	25	17,0	8 000071 929127
• 92913	75 X 50	1,80	2,15	120	25	20,8	8 000071 929134
• 92914	75 X 50	1,80	2,15	150	25	25,9	8 000071 929141
• 92915	75 X 50	1,80	2,15	180	25	31,0	8 000071 929158
• 92916	75 X 50	1,80	2,15	200	25	33,8	8 000071 929165

Rivestimento PVC colore verde conforme alla normativa RoHS

Coating complies with RoHS

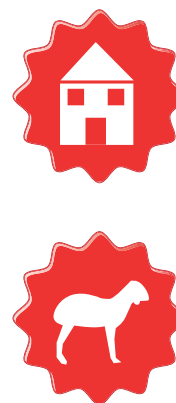
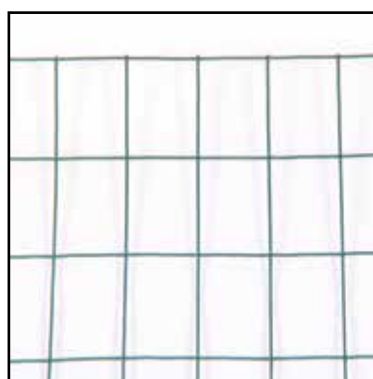
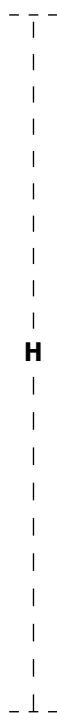



mod. BARRIER

	A	B	H cm	L m	Kg ca.	
• 92106	13	15	100	50	29,0	
• 92107	16	15	145	50	37,0	
• 92108	19	15	200	50	46,0	
• 92109	8	30	100	100	32,0	
• 92110	8	15	100	50	22,0	
• 92111	11	15	130	50	29,0	

Rete zincata a caldo maglia annodata con buona resistenza. Si adatta bene alla recinzione di allevamenti di animali.

Woven by hot dipped galvanized knotted mesh wire, the zinc is anti-corrosion. Work well for every animals farm.

Uso / Use

Recinzione per animali
Animals



Ø Filo / Wires

Ø filo 1,9 - 2,45 mm

Rivestimento zinco / Zinc coating

90 gr/m² ca.

Carico di rottura / Tensile strength

500-550 N/mm²

A = n° fili orizzontali / n° horizontal wires
B = distanza fili verticali (cm) / vertical wires distance (cm)

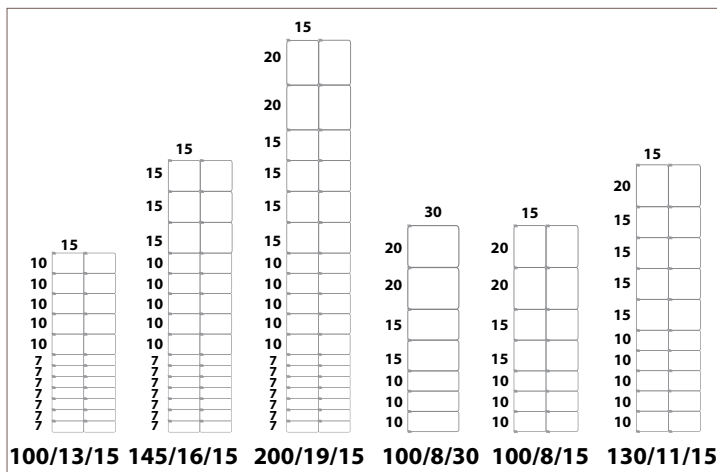



reti metalliche metal networks



mod. AREA LIGHT

Rete zincata a maglia sciolta, con finitura in PVC resistente alla corrosione e alla trazione, aiuta a mantenere forma ed elasticità.

Il rivestimento in PVC ha una buona stabilità di colore, resistenza all'invecchiamento e all'azione dei raggi UV.

It is made of plastic coated hard steel tensile wire chain link fence, to maintain shape and elasticity, the wire galvanized before coated, then woven to mesh. It has a high colour stability and UV resistant. Raw PVC are proved anti-fatigue.

Uso / Use

Recinzione per abitazioni, animali
Residences, animales



Rivestimento zinco / Zinc coating

30-40 gr/m² ca.

Rivestimento PVC / PVC coating

0,85 mm - col. Verde

Carico di rottura / Tensile strength

600 N/mm²

	maglia / mesh mm	ø filo / wire mm		H cm	L m	Kg ca.	Barcode
		zinc.	plast.				
94551	50 X 50	1,65	2,50	100	25	20	8 000071 945516
94552	50 X 50	1,65	2,50	125	25	25	8 000071 945523
94553	50 X 50	1,65	2,50	150	25	30	8 000071 945530
94554	50 X 50	1,65	2,50	175	25	35	8 000071 945547
94555	50 X 50	1,65	2,50	200	25	40	8 000071 945554

Rivestimento PVC colore verde conforme alla normative

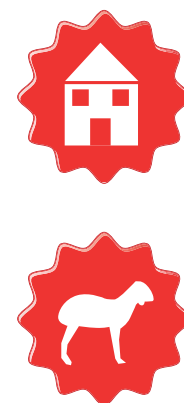
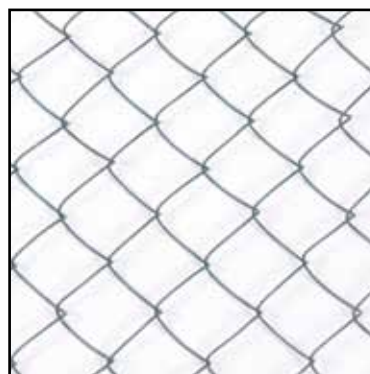



Cancelli pedonali con pali

Colore Verde - Maglia 100x50 mm
 Telaio tubolare tondo Ø 38x1,5 mm
 Chiusura a gancio

Pedestrian gates with poles
 Green colour - Mesh 100x50 mm
 Round tubular frame Ø 38x1,5 mm
 Hook locking



mod. PINCIO



	Filo / Wire	Altezza Height	Larghezza Width	Palo / Pole Ø x H cm	Kg ca.	
• 93316	Ø 4 mm	100 cm	100 cm	4,8x150	12,2	
• 93317	Ø 4 mm	120 cm	100 cm	4,8x170	14,0	
• 93318	Ø 4 mm	150 cm	100 cm	4,8x200	16,7	



Cancelli pedonali a battente con pali

Col Verde - Maglia 100x50 mm
 Telaio tubolare quadrato 40x40 mm
 Maniglia plastica - Battente in ferro
 Serratura standard europeo con cilindro

Pedestrian gates wing with poles
 Green colour - Mesh 100x50 mm
 Square tubular frame 40x40 mm
 Plastic handle - Iron wing
 Lock european standard type with keys cylinder



mod. TIVOLI



	Interasse Wheelbase	Altezza Height	Palo / Pole Ø x H cm	Kg ca.	
• 93320	100 cm	115 cm	6x190	26,0	
• 93321	100 cm	145 cm	7,6x225	32,0	

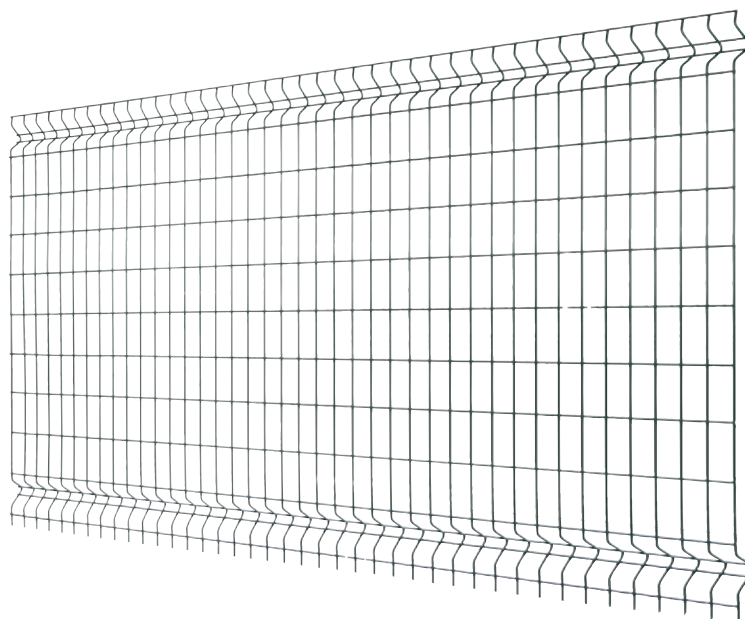

• mod. BORDER •

Pannelli modulari zincati a caldo, plastificati
colore verde
Maglia 100x50 mm
Ø Filo 4,5/4,0 mm
Larghezza 200 cm

Hot dipped galvanized panels, green colour plastified
Mesh mm 100x50
Ø Wire mm 4,5/4,0
Width cm 200

	Altezza / Height	Nervature orizzontali Horizontal reinforcements	
• 93866	103 cm	2	 8 000071 938662
• 93867	123 cm	2	 8 000071 938679
• 93868	153 cm	2	 8 000071 938686
• 93892	173 cm	3	 8 000071 938921
• 93869	203 cm	3	 8 000071 938693

• Installazione pannelli linea BORDER / How to install panels BORDER line

Pannelli altezza (cm)	103	123	153	173	203
Altezza pali per posa su cordolo calcestruzzo / plinto isolato (cm)	150	170	200	250	250
Altezza pali per posa con supporto 61436	110	130	-	-	-
N° supporto per pali 61436	1	1	-	-	-
N° collari fissaggio	2	3	3	4	4
N° piastrine angolari	2	3	3	4	4
N° kit angolari inox	1	1	-	-	-



• mod. BORDER •

Pali recinzione zincati, plastificati Colore verde		Galvanized posts Green colour plastified	
	Ø mm	H cm	
• 93877	48 x 1,5	110	8 000071 938778
• 93878	48 x 1,5	130	8 000071 938785
• 93879	48 x 1,5	150	8 000071 938792
• 93880	48 x 1,5	170	8 000071 938808
• 93881	48 x 1,5	200	8 000071 938815
• 93882	48 x 1,5	250	8 000071 938822



Pali recinzione zincati, plastificati colore verde, con tracciafilo

Galvanized posts, green colour plastified, for wire mesh

	Ø mm	H cm	
• 93870	38 x 1,25	100	8 000071 938709
• 93871	38 x 1,25	120	8 000071 938716
• 93872	38 x 1,25	150	8 000071 938723
• 93873	38 x 1,25	170	8 000071 938730
• 93874	38 x 1,25	200	8 000071 938747
• 93875	48 x 1,50	230	8 000071 938754
• 93876	48 x 1,50	260	8 000071 938761



Supporto plastificato quadro per pali Ø 48 mm / Square plastified support for posts Ø 48 mm

• 61436

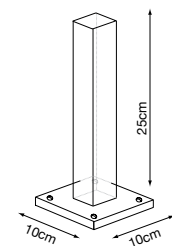



Paletti - profilo ferro a T Zincati	Iron posts - T profile Galvanized
50597	100 cm 
50598	125 cm 
50599	150 cm 
50600	175 cm 
50601	200 cm 
50602	225 cm 
50603	250 cm 

Paletti - profilo ferro a T Plastificati	Iron posts - T profile Plastified
50604	100 cm 
50605	125 cm 
50606	150 cm 
50607	175 cm 
50608	200 cm 
50609	225 cm 
50610	250 cm 



Saette - profilo ferro a L Zincati	Iron struts - U Galvanized
50611	120 cm 
50612	155 cm 
50613	200 cm 



Saette - profilo ferro a L Plastificati	Iron struts - U Plastified
50614	120 cm 
50615	155 cm 
50616	200 cm 



Filo spinato zincato / Galvanized barbed wire

	ø int. mm	L m	
• 95274	1,7	100	

Filo spinato plastificato / Galvanized barbed wire

	ø int. mm	ø est. mm	L m	
• 95275	1,6	2,1	50	
• 95276	1,6	2,1	100	

Rivestimento PVC colore verde conforme alla normativa RoHs

Coating complies with RoHs



Filo plastificato per reti - colore verde / Low carbon steel wire - PVC coated - col. green (confezione etichetta)

	Tipo / Type	ø est. mm	L m	Kg ca.	
• 91894	di tensione / stiff	2,4	100	2,0	
• 93139	di tensione / stiff	2,8	100	3,0	
• 91324	di tensione / stiff	3,2	100	4,0	
• 91895	di tensione / stiff	3,6	100	6,0	
• 91325	di legatura / tie up soft	1,6	100	1,0	
• 92920	di tensione / stiff	3,1	25,0		
• 93507	di legatura / tie up soft	1,8	25,0		







versione con etichetta



versione confezionata con imballo termoretraibile

Filo plastificato per reti - colore verde / Low carbon steel wire - PVC coated - col. green (confezione termoretraibile)

	Tipo / Type	ø est. mm	L m	Kg ca.	
• 95266	di tensione / stiff	2,4	100	2,0	
• 95267	di tensione / stiff	2,8	100	3,0	
• 95268	di tensione / stiff	3,2	100	4,0	
• 95269	di tensione / stiff	3,6	100	6,0	
• 95272	di legatura / tie up soft	1,6	100	1,0	

Filo zincato con finitura in PVC resistente alla corrosione. Il rivestimento ha una buona stabilità di colore, resistenza all'invecchiamento e all'azione dei raggi UV.

Made of plastic coated low carbon steel wire, then wire is galvanized before plastic coated. The PVC coated as a high colour stability and UV resistant.

Rivestimento zinco / Zinc coating

25 gr/m2 ca. - col. Verde

Rivestimento PVC / PVC coating

0,6-1,05 mm

Rivestimento PVC colore verde conforme alla normativa RoHs

Coating complies with RoHs



filo per reti wire fencing



versione con etichetta



versione confezionata con imballo termoretraibile



Filo zincato per reti / Low carbon galvanized wire (confezione etichetta)

	Tipo / Type	Ø est. mm	L m	Kg ca.	
• 92918	di tensione / stiff	2,0	100	3,0	8 000071 929189
• 92919	di tensione / stiff	2,5	100	4,5	8 000071 929196
• 92917	di legatura / tie up soft	1,8	100	2,0	8 000071 929172

Filo zincato per reti / Low carbon galvanized wire (confezione termoretraibile)

	Tipo / Type	Ø est. mm	L m	Kg ca.	
• 95270	di tensione / stiff	2,0	100	3,0	8 000071 952705
• 95271	di tensione / stiff	2,5	100	4,5	8 000071 952712
• 95273	di legatura / tie up soft	1,8	100	2,0	8 000071 952736

legatura tying supplies



Rotolino filo zincato / Dispenser con taglierina Hot-dip galvanized wire / Dispenser with cutter

• 97145	Ø 0,70 mm x 100 m	8 000071 971454
• 97146	Ø 1,00 mm x 50 m	8 000071 971461
• 97147	Ø 1,25 mm x 25 m	8 000071 971478

Rotolino filo plastificato - col. verde / Dispenser con taglierina PVC coated wire - col. green / Dispenser with cutter

	Ø interno / esterno	Lunghezza	
• 97148	0,80 mm / 1,25 mm	50 m	8 000071 971485
• 97149	1,10 mm / 1,60 mm	25 m	8 000071 971492



Piattina animata con filo metallico
Ricoperta in PVC (colore verde)
Dispenser con taglierina

Utility twist tie (green color)
Center wire steel
Dispenser with cutter

• 82048

50 m



Piattina animata con filo metallico
Ricoperta in PVC (colore verde)
Spezzoni – 1000 pezzi

Utility twist tie (green color)
Center wire steel
1000 pcs

99335

15 cm



99336

20 cm



95724

25 cm



Piattina animata con filo metallico
Ricoperta in carta (colore avana)
Spezzoni – 1000 pezzi

Paper utility twist tie
Center wire steel
1000 pcs

99337

15 cm



99338

20 cm



99339

25 cm



Tubetto PVC per legatura
Colore verde
Conf. gomitolo

PVC tube
Green color

99340

Ø 2,5 mm

1 Kg



99341

Ø 3 mm

1 Kg



99342

Ø 4 mm

1 Kg



99343

Ø 5 mm

1 Kg



99344

Ø 6 mm

2 Kg





legatura tying supplies



Pinza legatrice manuale

Leggera e facile da utilizzare
Ideale nel settore del giardinaggio, orticoltura, viticoltura per il fissaggio di rami, piante, vitigni.
Incluso nella confezione: 1 nastro PVC, 1 scatola punti, 1 set ricambio (lama, vite e molla).

Hand Tying machine
Lightweight and easy to use.
Ideal in gardening, horticulture, viticulture for fixing branches, plants, vines.
Included in the package: 1 PVC tape, 1 box of staples, 1 replacements set (blade, screw and spring).

• 99326

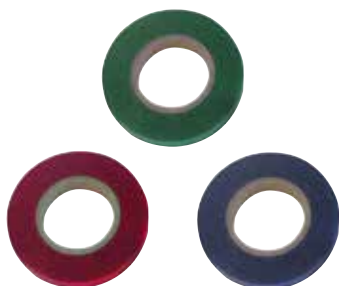

Nastri PVC per pinza legatrice / PVC tape for tying machine

	colore	Larghezza / Lunghezza	Spessore	
• 99327	VERDE	11mm x 26 m	0,15 mm	
• 99328	ROSSO	11mm x 26 m	0,15 mm	
• 99329	BLU	11mm x 26 m	0,15 mm	
• 99330	ROSSO	11mm x 16 m	0,25 mm	

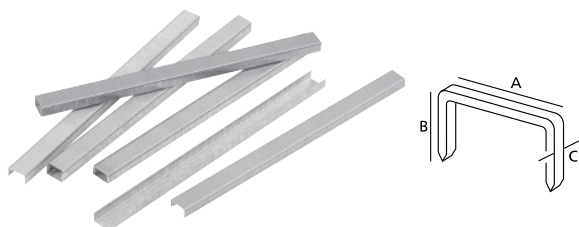

Punti per pinza legatrice - 604C (10000 pz) / Staples - 604C (10000 pcs)

• 99331

A: 6 mm / B: 4 mm / C: 0,5 mm



Set 3 pz lame di ricambio per legatrice / Set 3 pcs spare blade

• 99352





MAURER

Filo ferro plastificato
In matasse









Iron wire plastified
Skein

	N°	ø mm	m	
• 89215	2	0,8	40	
• 89216	4	0,9	30	
• 89217	6	1,2	20	
• 89218	8	1,3	16	
• 89219	10	1,5	12	
• 89220	12	1,8	9	
• 89221	14	2,2	8	

MAURER

Filo ferro zincato
In matasse

Iron wire galvanized
Skein

	N°	ø mm	m	
• 89222	2	0,8	40	
• 89223	4	0,9	30	
• 89224	6	1,2	25	
• 89225	8	1,3	22	
• 89226	10	1,5	16	
• 89227	12	1,8	12	
• 89228	13	2,0	10	
• 89229	14	2,2	9	
• 89230	15	2,5	7	

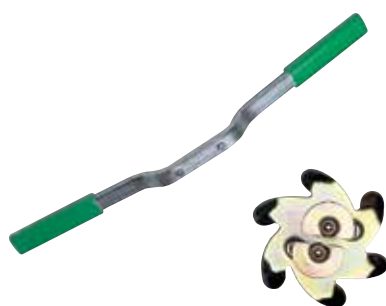

Tendifilo per vigneti
Lamiera zincata

Vineyard wire stretcher
Galvanized sheet

52576

n. 1

52577

n. 2

Maniglia tendifilo / Wire stretcher handle

52578



Filo raffia per legature / Raffia wire for binding

82047

200 m



8 000071 820479



accessori per pali accessories for posts



Collari per saette - Kit 3 pezzi		Collars for struts - 3 pcs set	
	Ø mm	Viti / Screw	
• 61459	38 / 38	1	8 000071 614597
• 61460	48 / 48	2	8 000071 614603

Tracciafilo per pali - Kit 20 pezzi		Post wire track - 20 pcs set	
• 61440			8 000071 614405



• mod. BORDER •

Piastrine ad angolo INOX
confezione in kit di 2 SET
complete di piastrine e viti
con dado
Per pali serie BORDER

Steel angular plates 2 sets
complete with clips and
screws with nuts
For poles series BORDER

• 61438



• mod. BORDER •

Piastrine INOX per fissaggio
pannelli ad angolo
(conf. 10 pezzi)
Per pali serie BORDER

Steel clips for fixing panels in
angle (pack 10 pieces)
For poles series BORDER

• 61439



• mod. BORDER •

Collari plastica con viti INOX
(conf. 6 pezzi)
Per pali serie BORDER

Plastic collars with inox screws
(pack 6 pieces)
For poles series BORDER

• 61437



Tenditori per fili Acciaio verniciato		Wire pullers Painted steel	
• 83600	n. 2		8 000071 836005
Acciaio zincato		Galvanized steel	
• 52579	n. 2		8 000071 525794



**ILLUMINAZIONE,
ACCESSORI E TEMPO LIBERO**



**CATALOGO
GIARDINAGGIO
2017**



carricole wheelbarrows

**MAURER**

In lamiera zincata
Vasca lamiera stampata
Capacità 70 litri
Smontata
Ruota pneumatica

Galvanized steel pan barrow
Steel pan
Capacity 70 litres
Disassembled
Pneumatic with

91789

8 000071 917896

**MAURER**

In lamiera verniciata
Vasca lamiera stampata
Capacità 70 litri
Ruota pneumatica

Painted steel pan barrow
Steel pan
Capacity 70 litres
Pneumatic with

91788

8 000071 917889



PER ALIMENTI

MAURER

Vasca in polipropilene
Indeformabile, rinforzata sui bordi
Atossica, adatta ad uso alimentare
Capacità 100 litri
Smontata
Telaio tubolare acciaio verniciato 30 mm
Ruota pneumatica con cerchione in
plastica

Universal wheelbarrow
Rustproof polypropylene pan with
rolled edge
Non-toxic, suitable for food use
Capacity 100 litres
Disassembled
30 mm painted tubular framework
Pneumatic tyre with plastic wheel rim

91790

8 000071 917902

**MAURER**

Vasca in plastica
Capacità 100 litri
Ruota pneumatica

Plastic pan
Capacity 100 litres
Pneumatic with

• 93929

8 000071 939294

Ruota pneumatica
ricambio per cod. 93929

Pneumatic spare
wheel for cod. 93929

• 61359

8 000071 613590

Ruota piena PU (colore giallo)
ricambio per cod. 93929

PU foam Spare wheel (yellow color)
for cod. 93929

• 98408

8 000071 984089

**Ricambi per carriole** / Wheelbarrows parts

61132	Vasca in polipropilene / Polypropylene pan	
61130	Vasca in lamiera verniciata / Painted sheet pan	
61131	Vasca in acciaio zincato / Galvanized steel pan	

**MAURER**

Ruote pneumatica - Gomma nera / Pneumatic wheels - black tires
Disco acciaio / Steel hub

• 93707	asse mozzo 170 mm	
• 92997	asse mozzo 205 mm	

Ruote piena PU - Gialla / PU wheels - Yellow
Disco acciaio / Steel hub

• 94704	asse mozzo 170 mm	
• 94698	asse mozzo 205 mm	

**papillon****Carretto per giardino**

Telaio acciaio verniciato / Painted steel framework
Pianale e sponde griglia acciaio verniciato / Painted wire netting platform and sides
Sponde laterali ribaltabili / Tilting lateral sides
Sponde laterali ribaltabili / Pneumatic tyres Ø 260 mm
Ruote pneumatiche Ø 260 mm / Size 52x96x25 cm
Dimensione 52x96x25 cm / Height at top 58 cm
Altezza al piano 58 cm / Capacity 250 Kg
Portata 250 Kg

• 92551 

Ruota di ricambio per cod. 92551 / Spare wheel for cod. 92551

• 61617 





carrelli hand trucks



MAURER

mod. NADIR

Estensibile e pieghevole

Dimensioni: cm 39x41x101 H
 Piano d'appoggio pieghevole 39x28 cm
 Telaio in alluminio
 Ruote gomma-nylon Ø 130 mm
 Portata 60 Kg
 Peso 3,75 Kg

Extensible and foldable
 Dimensions: cm 39x41x101 H
 Folding support surface 39x28 cm
 Aluminium frame
 Solid rubber-nylon wheels Ø 130 mm
 Capacity 60 Kg
 Weight 3,75 Kg

• 91766



MAURER

mod. ANTARES

Estensibile e pieghevole

Dimensioni: cm 49x46x96,5 H
 Piano d'appoggio pieghevole 49x27 cm
 Telaio in alluminio
 Ruote gomma-nylon Ø 180 mm
 Portata 90 Kg
 Peso 4,75 Kg

Extensible and foldable
 Dimensions: cm 49x46x96,5 H
 Folding support surface 49x27 cm
 Aluminium frame
 Solid rubber-nylon wheels Ø 180 mm
 Capacity 90 Kg
 Weight 4,75 Kg

• 91767



papillon

Carrello raccoglitorutto

Per raccolta di erba, foglie e rifiuti
 Con sacco N.U. e coperchio

Trash cart
 Pick-up grass, leaves, waste materials
 With cover and PE bag

• 86939





MAURER

mod. JUPITER-L

Carrello in acciaio verniciato

Per vasi e scatole

Dimensioni: mm 540x760x1080 H

Piano d'appoggio ribaltabile mm 530x290

Telaio tubolare acciaio verniciato 25 mm

Ruote pneumatiche 260x85 mm

Peso: 12,5 Kg

Portata 200 Kg

Painted steel trucks

For sacks and drums

Dimensions: mm 540x760x1080 H

Folding support surface: mm 530x290

25 mm painted tubular frame

260x85 mm pneumatic tyres

Weight: 12,5 Kg

Capacity: 200 Kg

• 88760



MAURER

mod. ZEUS-L

Carrello in acciaio verniciato

Per casse, scatole e fusti

Dimensioni: mm 530x460x1050 H

Piano d'appoggio mm 450x220

Telaio tubolare acciaio verniciato 25 mm

Ruote pneumatiche 260x85 mm

Peso: 10 Kg

Portata 200 Kg

Painted steel trucks

For sacks and drums

Dimensions: mm 530x460x1050 H

Support surface: mm 450x220

25 mm painted tubular frame

260x85 mm pneumatic tyres

Weight: 10 Kg

Capacity: 200 Kg

• 84539



MAURER

mod. LEO

Carrello in acciaio verniciato

Per casse e scatole

Dimensioni: mm 500x510x1170 H

Piano d'appoggio mm 450x260

Telaio tubolare acciaio verniciato 25 mm

Ruote pneumatiche 260x85 mm

Peso: 10 Kg

Portata 200 Kg

Painted steel trucks

For sacks and drums

Dimensions: mm 500x510x1170 H

Support surface: mm 450x260

25 mm painted tubular frame

260x85 mm pneumatic tyres

Weight: 10 Kg

Capacity: 200 Kg

• 87128





proiettori led led floodlight



led
CE IP65

MAURER

Corpo in alluminio con staffa
Temperature colore 4000 Kelvin
Fascio luminoso 120°

Aluminium body and stand
Color temperature 4000 Kelvin
Beam angle 120°

• **99373** 750 Lumen 10 watt  8 000071 993739

• **99374** 1700 Lumen 20 watt  8 000071 993746

• **97756** 2550 Lumen 30 watt  8 000071 977562

• **97757** 4250 Lumen 50 watt  8 000071 977579

• **97758** 8500 Lumen 100 watt  8 000071 977586

led
CE IP65



MAURER

Corpo in alluminio con staffa
Temperature colore 4000 Kelvin
Fascio luminoso 120°

Aluminium body and stand
Color temperature 4000 Kelvin
Beam angle 120°

• **99377** 900 Lumen 10 watt  8 000071 993777

• **99378** 1800 Lumen 20 watt  8 000071 993784

led
CE IP65



MAURER

Con sensore
Corpo in alluminio con staffa
Temperature colore 4000 Kelvin
Fascio luminoso 120°

With sensor
Aluminium body and stand
Color temperature 4000 Kelvin
Beam angle 120°

• **96540** 720 Lumen 10 watt  8 000071 965408



led
CE IP65



led
CE IP65



led
CE IP65

MAURER

Modello portatile	Portable model
Corpo in alluminio	Aluminium body
Temperature colore 4000 Kelvin	Color temperature 4000 Kelvin
Fascio luminoso 120°	Beam angle 120°

• **96541** 1440 Lumen 20 watt 8 000071 965415

MAURER

Modello portatile	Portable model
Corpo in alluminio	Aluminium body
Temperature colore 4000 Kelvin	Color temperature 4000 Kelvin
Fascio luminoso 120°	Beam angle 120°

• **97759** 3600 Lumen 50 watt 8 000071 977593



led
CE IP44



led
CE IP44

MAURER

Con batteria ricaricabile	Rechargeable
Corpo in alluminio	Aluminium body
2 livelli di potenza (600 / 300 lm)	2 light regulation (600 / 300 lm)
Temperature colore 4000 Kelvin	Color temperature 4000 Kelvin
Fascio luminoso 120°	Beam angle 120°
Durata 3 ore / 6 ore	Battery life 3h / 6h
Tempo di ricarica 6 ore	Charging time 6h
Batteria al litio da 3.7V - 6000 mAh	Lithium battery 3.7V - 6000 mAh
Con caricabatteria e adattatore auto	With charger and car adapter

• **98982** 600 Lumen 10 watt 8 000071 989824

MAURER

Con batteria ricaricabile	Rechargeable
Corpo in alluminio	Aluminium body
2 livelli di potenza (2000 / 1000 lm)	2 light regulation (2000 / 1000 lm)
Temperature colore 4000 Kelvin	Color temperature 4000 Kelvin
Fascio luminoso 120°	Beam angle 120°
Durata 3 ore / 6 ore	Battery life 3h / 6h
Tempo di ricarica 10 ore	Charging time 10h
Batteria al litio da 3.7V - 16000 mAh	Lithium battery 3.7V - 16000 mAh
Con caricabatteria e adattatore auto	With charger and car adapter

• **98984** 2000 Lumen 30 watt 8 000071 989848



proiettori led led floodlight



led
CE IP44



FUNZIONE
POWERBANK

MAURER

Con batteria ricaricabile

2 livelli di potenza (1400 lm / 700 lm)
Funzione SOS (luce rossa lampeggiante)
Temperature colore 4000 Kelvin
Fascio luminoso 150°
Durata 3 ore / 6 ore
Tempo di ricarica 8 ore
Batteria al litio da 3.7V - 8000 mAh
Con caricabatteria e adattatore per auto
Funzione POWERBANK - per alimentare e caricare
smartphone e i più comuni dispositivi mobili

Rechargeable
2 light regulation (1400 lm / 700 lm)
SOS function (flashing red light)
Color temperature 4000 Kelvin
Beam angle 150°
Battery life 3h / 6h
Charging time 8h
Lithium battery 3.7V - 8000 mAh
With charger and car adapter
POWERBANK function - power and recharge
mobile phone and other mobile device

• 98983

1400 Lumen

20 watt



VANO PORTA ACCESSORI



FUNZIONE SOS

proiettori alogeni halogen lamps



CE IP44 F

MAURER

Modello rettangolare fisso con staffa

Rectangular fixed model with stand

• 53271

400 watt



• 94106

1000 watt



Modello ovale fisso con staffa

Oval fixed model with stand

• 88178

120 watt



• 88179

230 watt



CE IP44 F



MAURER

Con sensore

Modello ovale fisso con staffa

With sensor

Oval fixed model with stand

• 88183

230 watt



CE IP44 F



MAURER

Modello rettangolare portatile
Con griglia di protezione

Rectangular portable model
With safety grill

• 52673

400 watt





CE

MAURER

Supporto regolabile per proiettore
Altezza 64÷160 cm

Floodlight tripod
Height 64÷160 cm

• 97761

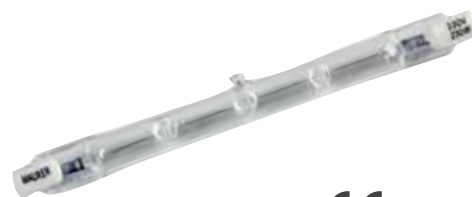

CE

MAURER

Lampade alogene lineari

Attacco R7s
Temperatura colore 2850°K
UV STOP - filamento assiale
Posizione di funzionamento
orizzontale ± 15°

Linear halogen lamps
Socket R7s
Colour temperature 2850°K
UV STOP - axial filaments
Operating position horizontal ± 15°

• 93250	120 watt	78 mm	
• 93251	230 watt	118 mm	
• 93252	400 watt	118 mm	
• 91113	1000 watt	189 mm	

IP43 CE

papillon

ELYSIUM

Struttura in pressofusione di alluminio
Diffusore in policarbonato
Portalampada E27 in porcellana
Accessori di montaggio inclusi
Dim. 16 x 21 x 60 cm
(lampada esclusa)

Structure in die-cast aluminium
Polycarbonate diffuser
Porcelain lamp holder E27
Assembling accessories including
Dim. 16 x 21 x 60 cm
(lamp not included)

• 96785

bianco / white



• 96786

grigio / grey

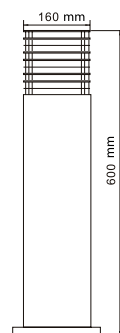
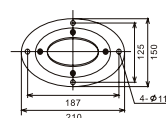



lanterne e lampioni lanterns and street lamps

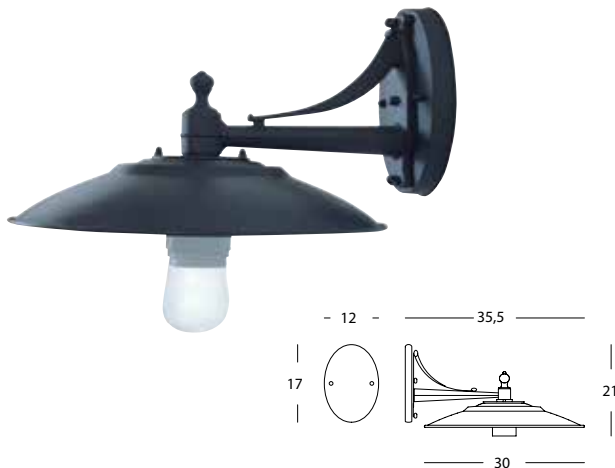

IP43 F CE



RETRO

Mod. BASSO

Dimensioni: 35,5 x 21 H cm
 Alluminio pressofuso, piatto smaltato bianco nella parte inferiore, portalampada E27 in porcellana con guarnizione gomma silconica
 Controbase e accessori di montaggio inclusi (lampada esclusa)
 Colore nero

Mod. LOW
 Sizes: 35,5 x 21 H cm
 Molten aluminium, plate enamelled white on the inside, porcelain lamp holder E27 with silicon rubber gasket
 Holder base and assembling accessories including (lamp not included)
 Black colour

• 93832



CLIPPER

Alluminio pressofuso, diffusori in termoplastico trasparente, portalampada E27 in porcellana
 Controbase e accessori di montaggio inclusi (lampada esclusa)
 Colore ruggine

Molten aluminium, thermoplastic transparent diffusers, porcelain lamp holder E27
 Holder base and assembling accessories including (lamp not included)
 Rust colour

IP43 F CE

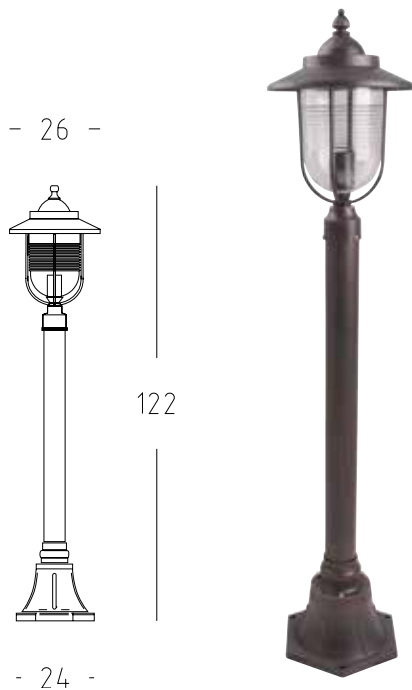

mod. LAMPIONE
 Dimensioni: 26 x 122 H cm

mod. HANGING
 Sizes: 26 x 122 H cm

• 92625



mod. BASSO-S
 Dimensioni: 27 x 34 H cm

mod. LOW-S
 Sizes: 27 x 34 H cm

• 92622





CHIC

Alluminio pressofuso, diffusori in vetro, portalampada E27 in porcellana
Controbase e accessori di montaggio inclusi (lampada esclusa)
Colore bianco

Molten aluminium, glass diffusers, porcelain lamp holder E27
Holder base and assembling accessories including (lamp not included)
White colour

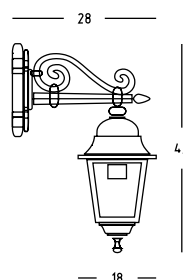
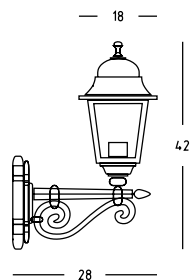

mod. ALTO
Dimensioni: 28 x 42 H cm

mod. HIGH
Sizes: 28 x 42 H cm

• 95499



mod. BASSO
Dimensioni: 28 x 42 H cm

mod. LOW
Sizes: 28 x 42 H cm

• 95500

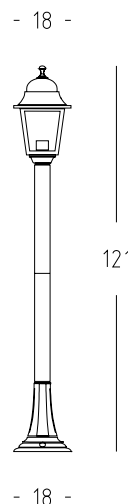
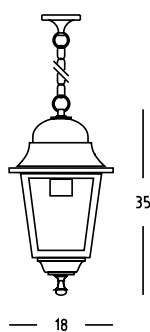

mod. SOSPENSIONE
Dimensioni: 18 x 35 H cm

mod. HANGING
Sizes: 18 x 35 H cm

• 95501



mod. LAMPIONE
Dimensioni: 18 x 121 H cm

mod. STREET LAMP
Sizes: 18 x 121 H cm

• 95502





lanterne e lampioni lanterns and street lamps

IP43 F CE



CHARME

Alluminio pressofuso, diffusori in vetro, portalampana E27 in porcellana
Controbase e accessori di montaggio inclusi (lampada esclusa)
Colore nero

Molten aluminium, glass diffusers, porcelain lamp holder E27
Holder base and assembling accessories including (lamp not included)
Black colour

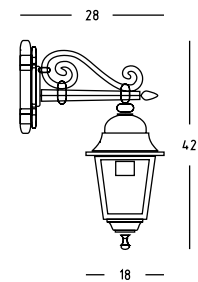
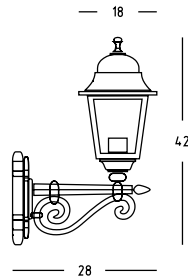

mod. ALTO
Dimensioni: 28 x 42 H cm

mod. HIGH
Sizes: 28 x 42 H cm

• 92602



mod. BASSO
Dimensioni: 28 x 42 H cm

mod. LOW
Sizes: 28 x 42 H cm

• 92603

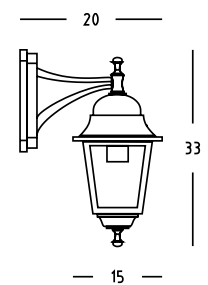
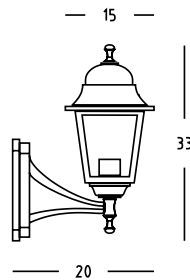

mod. MINI-ALTO
Dimensioni: 20 x 33 H cm

mod. MINI-HIGH
Sizes: 20 x 33 H cm

• 92589



mod. MINI-BASSO
Dimensioni: 20 x 33 H cm

mod. MINI-LOW
Sizes: 20 x 33 H cm

• 92579





CHARME

Alluminio pressofuso, diffusori in vetro, portalamпада E27 in porcellana
Controbase e accessori di montaggio inclusi (lampada esclusa)
Colore nero

Molten aluminium, glass diffusers, porcelain lamp holder E27
Holder base and assembling accessories including (lamp not included)
Black colour



mod. MINI-SOSPENSIONE
Dimensioni: 18 x 35 H cm

mod. MINI-HANGING
Sizes: 18 x 35 H cm

• 92599



mod. LAMPIONE
Dimensioni: 18 x 121 H cm

mod. STREET LAMP
Sizes: 18 x 121 H cm

• 92600



mod. LAMPIONE 3 luci
Palo telescopico
Dim.: 54 x 137÷203 H cm

mod. STREET LAMP 3 lamps
Telescopic pole
Sizes: 54 x 137÷203 H cm

• 92601

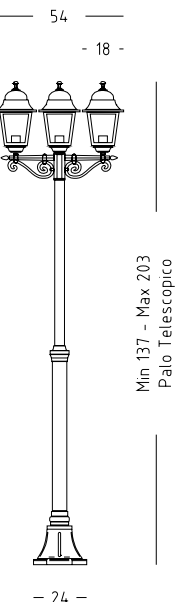

- 24 -



lanterne e lampioni lanterns and street lamps

IP43 CE



AVENIDA

Alluminio pressofuso, diffusori in vetro, portalampana E27 in porcellana. Controbase e accessori di montaggio inclusi (lampada esclusa). Colore nero/verde.

Molten aluminium, glass diffusers, porcelain lamp holder E27. Holder base and assembling accessories including (lamp not included). Black/green colour.

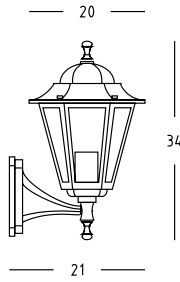

mod. ALTO

Dimensioni: 21 x 34 H cm

mod. HIGH

Sizes: 21 x 34 H cm

• 92604

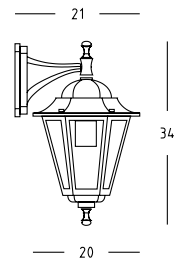

mod. BASSO

Dimensioni: 21 x 34 H cm

mod. LOW

Sizes: 21 x 34 H cm

• 92605



mod. SOSPENSIONE

Dimensioni: 20 x 32 H cm

mod. HANGING

Sizes: 20 x 32 H cm

• 92606

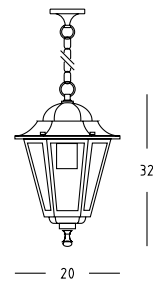



AVENIDA

Alluminio pressofuso, diffusori in vetro, portalamпада E27 in porcellana
Controbases e accessori di montaggio inclusi (lampada esclusa).
Colore nero/verde.

Molten aluminium, glass diffusers, porcelain lamp holder E27
Holder base and assembling accessories including (lamp not included).
Black/green colour.



mod. LAMPIONE Dimensioni: 20 x 121 H cm	mod. STREET LAMP Sizes: 20 x 121 H cm
---	--

• 92607



mod. LAMPIONE 3 luci Palo telescopico Dim.: 46 x 134÷200 H cm	mod. STREET LAMP 3 lamps Telescopic pole Sizes: 46 x 134÷200 H cm
--	---

• 92608

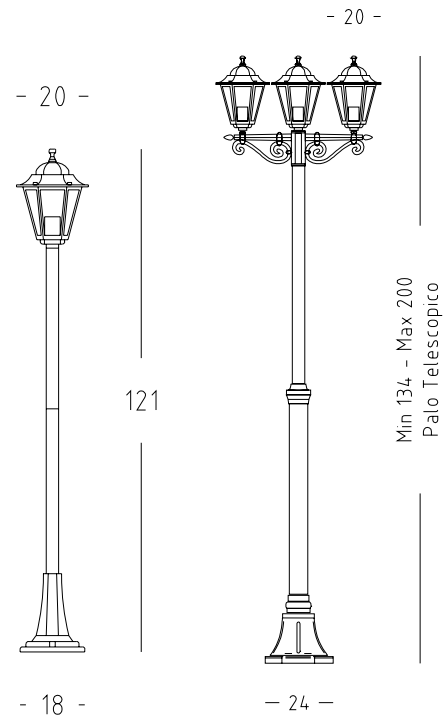



plafoniere LED LED ceilings

**MAURER**

Temperature colore 4000 Kelvin
Fascio luminoso 120°
Dimensione 17 x 7,3 cm

Color temperature 4000 Kelvin
Beam angle 120°
Dimensions 17 x 7,3 cm

• 98310

270 Lumen

4 watt



CE IP54 led

**MAURER**

Temperature colore 4000 Kelvin
Fascio luminoso 120°
Dimensione 17 x 7,3 cm

Color temperature 4000 Kelvin
Beam angle 120°
Dimensions 17 x 7,3 cm

• 98311

270 Lumen

4 watt



CE IP54 led

**MAURER**

Temperature colore 4000 Kelvin
Fascio luminoso 120°
Dimensione 26 x 11 cm

Color temperature 4000 Kelvin
Beam angle 120°
Dimensions 26 x 11 cm

• 98312

540 Lumen

9 watt



CE IP54 led

**MAURER**

Struttura in alluminio
Temperature colore 4000 Kelvin
Fascio luminoso 120°
Dimensione 21,5 x 13,5 x 7 cm

Aluminium body
Color temperature 4000 Kelvin
Beam angle 120°
Dimensions 21,5 x 13,5 x 7 cm

• 98313

500 Lumen

10 watt



CE IP65 led

**MAURER**

Temperature colore 4000 Kelvin
Fascio luminoso 115°
Dimensione 23 x 10,4 x 4,2 cm

Color temperature 4000 Kelvin
Beam angle 115°
Dimensions 23 x 10,4 x 4,2 cm

• 98955

1300 Lumen

18 watt



CE IP54 led



MEZZALUNA

Applique per esterni
Struttura in alluminio pressofuso
Diffusore in policarbonato opalino
Portalamпада E27 in porcellana
Accessori per il fissaggio inclusi
(lampada esclusa)
Colore grigio

Outdoor wall light
Molten aluminium frame
Opal polycarbonate diffuser
Porcelain lamp holder E27
Assembling accessories including
(lamp not included)
Grey colour

• 95263

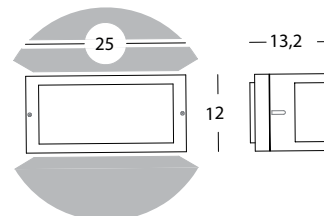

MEZZALUNA

Applique per esterni
Struttura in alluminio pressofuso
Diffusore in policarbonato opalino
Portalamпада E27 in porcellana
Accessori per il fissaggio inclusi
(lampada esclusa)
Colore grigio

Outdoor wall light
Molten aluminium frame
Opal polycarbonate diffuser
Porcelain lamp holder E27
Assembling accessories including
(lamp not included)
Grey colour

• 95264

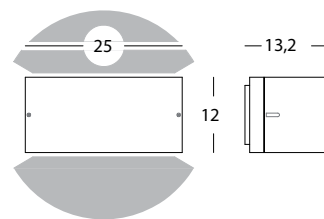

OVALE

Per esterni a parete/soffitto, con gabbia
Dimensioni: 10,7x21,3x9,5 cm
Struttura in alluminio pressofuso,
diffusore in vetro stampato trasparente,
portalamпада E27
in porcellana
Accessori di montaggio inclusi
(lampada esclusa)

Wall/ceiling outdoor, with cage
Sizes: 10,7x21,3x9,5 cm
Molten aluminium frame, transparent
moulded glass diffuser, porcelain lamp
holder E27
Assembling accessories including (lamp not
included)

• 92611

bianco / white



• 92610

nero / black



TONDO

Per esterni a parete/soffitto, con gabbia
Dimensioni: 19,2 x 10,2 cm
Struttura in alluminio pressofuso,
diffusore in vetro stampato trasparente,
portalamпада E27
in porcellana
Accessori di montaggio inclusi
(lampada esclusa)

Wall/ceiling outdoor, with cage
Sizes: 19,2 x 10,2 cm
Molten aluminium frame, transparent
moulded glass diffuser, porcelain lamp
holder E27
Assembling accessories including (lamp not
included)

• 92613

bianco / white



• 92612

nero / black





plafoniere ceilings



PALPEBRA

Alluminio pressofuso, diffusori in vetro stampato trasparente, portalampada in porcellana E27
Controbases e accessori di montaggio inclusi (lampada esclusa)

Molten aluminium, transparent moulded glass diffuser, porcelain lamp holder E27
Holder base and assembling accessories including (lamp not included)
Rust colour



IP54



IP54

mod. OVALE

Dim. 22,5 x 11,5 x 11,5 cm

mod. OVALE

Sizes 22,5 x 11,5 x 11,5 cm

• 92616

col. bianco / white



• 92614

col. nero / black



mod. OVALE MAXI

Dim. 30 x 13,5 x 17,3 cm

mod. OVALE MAXI

Sizes 30 x 13,5 x 17,3 cm

• 92617

col. bianco / white



• 92615

col. nero / black



IP54



IP54

mod. TONDA

Dim. 20 x 12 cm

mod. TONDA

Sizes 20 x 12 cm

• 92620

col. bianco / white



• 92618

col. nero / black



mod. TONDA MAXI

Dim. 25 x 15,5 cm

mod. TONDA MAXI

Sizes 25 x 15,5 cm

• 92621

col. bianco / white



• 92619

col. nero / black



IP44



TUSCIA

Per esterni a parete/soffitto, con gabbia
Dimensioni: 17x11x11,5 cm
Struttura in termoplastico, diffusore in vetro stampato trasparente, portalampada E27 in porcellana
Accessori di montaggio inclusi (lampada esclusa)
Colore bianco

Wall/ceiling outdoor, with cage
Sizes: 17x11x11,5 cm
Thermoplastic frame, transparent moulded glass diffuser, porcelain lamp holder E27
Assembling accessories including (lamp not included)
White colour

• 92609





Per esterni - con picchetto
 Dimens: Ø 9,8x9,5 cm
 Alluminio pressofuso, diffusore in vetro trasparente, portalamпада GU10 in porcellana
 Accessori di montaggio inclusi (lampada esclusa)
 Colore nero

For outdoor - with peg
 Size: Ø 9,8x9,5 cm
 Molten aluminium, glass transparent diffuser, porcelain lamp holder GU10
 Assembling accessories including (lamp not included)
 Black colour

• 93833



Per esterni - con staffa
 Dimens: Ø 9,8x9,5 cm
 Alluminio pressofuso, diffusore in vetro trasparente, portalamпада GU10 in porcellana
 Accessori di montaggio inclusi (lampada esclusa)
 Colore nero

For outdoor - with loop
 Size: Ø 9,8x9,5 cm
 Molten aluminium, glass transparent diffuser, porcelain lamp holder GU10
 Assembling accessories including (lamp not included)
 Black colour

• 93834



Per esterni da incasso
 Dimens: 23,3x10,1H cm
 Alluminio pressofuso, diffusore in vetro satinato bianco
 Portalamпада E27 in porcellana
 Controscatola termoplastico inclusa (lampada esclusa)
 Colore nero

Recessed outdoor light
 Sizes: 23,3x10,1H cm
 Molten aluminium, satin white glass
 Diffuser, porcelain lamp holder E27
 Flash box including (lamp not included).
 Black colour

• 93835

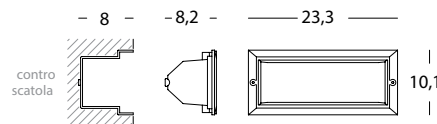

HELIOS

Struttura in plastica robusta e duratura
 Ricarica con luce solare durante il giorno e accensione automatica alla sera
 Lunga durata di luce
 Senza fili. Si installa in pochi secondi
 Batteria NI-MH AA 600 mAh - 1,2V
 Tecnologia LED avanzata

Strong and durable plastic construction
 Recharges by sunlight during the day and automatically turns-on at night
 Stays lit longer
 No wiring. Assembles and installs in a few seconds
 NI-MH battery AA 600 mAh - 1,2V
 Advanced LED technology

• 92923

finitura col. nero
 finish black color



• 92924

finitura acciaio inox
 finish stainless steel







torce bambù bamboo torches



Torce tipo intrecciato
Con contenitore in metallo

Bamboo torch
With metal can

• **94579** H 60 cm 

• **94580** H 90 cm 

• **94581** H 120 cm 

• **94582** H 150 cm 

Modello da tavolo / Table model

• **94583** H 35 cm 

Stoppino in fibra di vetro (10 pz) / Fiberglass wick (10 pcs)

• **94585** 12 cm 

• **94586** 21 cm 

olio per lampade lamp oil



Olio per lampade alla citronella
Repellente per insetti e zanzare

Citronella lamp oil
Insect repellent

94754 1 Litro 

fiaccola alla citronella citronella candles



Repellente per insetti e zanzare
Ciotola in alluminio

Insect repellent
Aluminum bowl

95202 Ø 14 x H 2,5 cm 

95203 Ø 17,5 x H 2,5 cm 

Repellente per insetti e zanzare
Ciotola in terracotta

Insect repellent
Earthenware bowl

95204 Ø 15 x H 3,5 cm 

95205 Ø 17,5 x H 3,5 cm 



30 m²
RAGGIO
D'AZIONE



CE

MAURER

Potenza 15 watt
Con ventola d'aspirazione
1 lampada fluorescente da 7 W
30 m² raggio d'azione
Dim. 22 x 11,7 x 22,5 cm

Power 15 watt
With aspiration fan
One fluorescent lamp 7 W
30 m² coverage
Dim. 22 x 11,7 x 22,5 cm

• 94549



40 m²
RAGGIO
D'AZIONE



CE

MAURER

Potenza 18 watt
Con ventola d'aspirazione
1 lampada fluorescente da 13W
40 m² raggio d'azione
Dim. 19,3 x 13 x 32 cm

Power 18 watt
With aspiration fan
One fluorescent lamp 13 W
40 m² coverage
Dim. 19,3 x 13 x 32 cm

• 94550



15 m²
RAGGIO
D'AZIONE



CE

MAURER

Potenza 6 watt
1 lampada fluorescente da 6 W
15 m² raggio d'azione
Dim. ø 13 x 30 cm

Power 6 watt
One fluorescent lamp (6 W)
15 m² coverage
Dim. ø 13 x 30 cm

• 93324



30 m²
RAGGIO
D'AZIONE



CE

MAURER

Potenza 19 watt
2 lampade fluorescenti da 6 W
20 m² raggio d'azione
Con trasformatore magnetico a scarica
continua di 2500 volt
Dim. 29 x 9 x 29 cm

Power 19 watt
Two fluorescent lamps (2x6W)
20 m² coverage
Magnetic transformer with continuous
discharge of 2500 volt
Dim. 29 x 9 x 29 cm

• 93325



Lampade di ricambio per elettroinsetticidi / Spare lamps for insect killers

• 61343

6 watt

per cod. 93324
cod. 93325



• 61344

10 watt

per cod. 93326



• 61345

15 watt

per cod. 94547



• 61346

20 watt

per cod. 94548





elettroinsetticidi insect killers

80 m²
RAGGIO
D'AZIONE

CE

**MAURER**

Potenza 28 watt
2 lampade fluorescenti da 10 W
30 m² raggio d'azione
Con trasformatore magnetico a
scarica continua di 2500 volt
Dim. 34 x 9 x 40 cm

Power 28 watt
Two fluorescent lamps (2x10 W)
30 m² coverage
Magnetic transformer with continuous
discharge of 2500 volt
Dim. 34 x 9 x 40 cm

• 93326



100 m²
RAGGIO
D'AZIONE

CE

**MAURER**

Potenza 39 watt
2 lampade fluorescenti da 15 W
40 m² raggio d'azione
Con trasformatore magnetico a scarica
continua di 2500 volt
Dim. 51,4 x 9 x 33,6 cm

Power 39 watt
Two fluorescent lamps (2x15W)
40 m² coverage
Magnetic transformer with continuous
discharge of 2500 volt
Dim. 51,4 x 9 x 33,6 cm

• 94547



CE

MAURER

Potenza 43 watt
2 lampade fluorescenti da 20 W
50 m² raggio d'azione
Con trasformatore magnetico a scarica
continua di 2500 volt
Dim. 65,9 x 9 x 33,6 cm

Power 43 watt
Two fluorescent lamps (2x20W)
50 m² coverage
Magnetic transformer with continuous
discharge of 2500 volt
Dim. 65,9 x 9 x 33,6 cm

• 94548



150 m²
RAGGIO
D'AZIONE

racchetta elettrica electronic swatter

**MAURER**

Racchetta elettrica
Elimina mosche e zanzare
Scarica elettrica da 2,4 Volt
Richiede 2 batterie AA (non incluse)

Electric mosquito swatter
Against flies and mosquitoes
2,4 Volt discharge
Requires 2 AA batteries (not included)

• 97123





MAURER

Repellente solare per talpe

Pannello solare 70x90 mm
Dim. Ø 15,5 x h 34 cm

Solar mole repeller
Solar panel 70x90 mm
Dim. Ø 15,5 x h 34 cm

625
m² RAGGIO
D'AZIONE

• 95277



MAURER

Repellente per topi

Doppio speaker
Dim. 18 x 7 x 8,5 cm

Electronic pest repeller
Double speaker
Dim. 18 x 7 x 8,5 cm

300
m² RAGGIO
D'AZIONE

• 95279



MAURER

Repellente per topi e insetti

2 tecnologie combinate
Onde ultrasuoni + onde
elettromagnetiche
Con luce notturna

Pest repeller
Ultrasonic waves combined with
electromagnetic waves
Built-in nightlight

200
m² RAGGIO
D'AZIONE

• 98959



MAURER

Repellente per topi e insetti

Con 3 speaker
Diffusione a 360°

Ultrasonic pest repeller
With 3 speakers
360° effect

400
m² RAGGIO
D'AZIONE

• 98960



MAURER

Repellente per topi e insetti

Con interruttore ON/OFF
Luce notturna

Electronic pest repeller
ON/OFF switch
With night light

60 m² RAGGIO
D'AZIONE

• 95278



MAURER

Repellente per zanzare

Spia a led

Electronic mosquito repeller
Led light

30 m² RAGGIO
D'AZIONE

• 95280





disinfestazione pest control

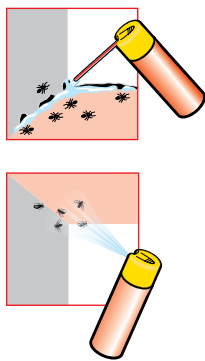

con cannuccia per
trattamenti localizzati
senza per un getto nebulizzato



Insetticida spray

Contro formiche, cimici e scarafaggi
Con cannuccia

Insect killer spray
Against ants, bedbugs and cockroaches
With straw

99189

500 ml



Antivespe spray

Contro vespe e nidi di vespe
Fino a 4 metri di distanza

Wasp killer spray
Against wasps and wasp nests
Up to 4 meters

97939

750 ml

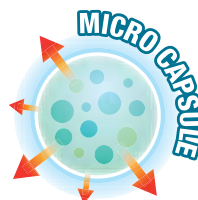

Insetticida spray

Contro mosche e zanzare
Per uso interno

Insect killer spray
Against flies and mosquitoes
Indoor use

99194

500 ml



Insetticida liquido

Microincapsulato
Multinsetto - Contro insetti volanti e
striscianti (cimici, mosche, zanzare,
formiche, acari, tarme, etc.)
Lunga persistenza

Liquid insecticide
Microencapsulated
Against flying and crawling insects
(bugs, flies, mosquitoes, ants, mites,
moths, etc.)
Long persistence

97940

500 ml





Larvicida antizanzare

10 compresse effervescenti
Contro tutte le specie di zanzare

Mosquito larvicide
10 effervescent tablets
Against all species of mosquitoes

97944

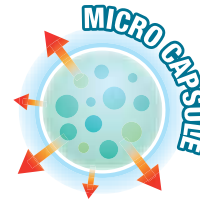

Insetticida concentrato

Microincapsulato
Multinsetto - Contro insetti volanti e striscianti (cimici, mosche, zanzare, formiche, acari, tarme, etc.)

Concentrated insecticide
Microencapsulated
Against flying and crawling insects (bugs, flies, mosquitoes, ants, mites, moths, etc.)

97941

50 ml



Esca antiformiche

2 trappole per confezione
Formula gel

Insecticide against ants
2 traps per pack
Gel formula

97942



Trappola adesiva per scarafaggi e blatte

5 trappole per confezione

Adhesive trap for beetles and cockroaches
5 traps per pack

97943



Trappola adesiva in faesite

Per la cattura di topi e ratti
Non contiene veleni
2 tavolette per confezione

Adhesive trap hardboard
For catching mice and rats
Without poisons
2 pieces per pack

97936

14x19 cm



97937

19x28 cm



Colla per topi

Non velenosa

Adhesive glue for catching rats
Without poison

97938

135 g





disinfestazione pest control



Esca roenticida in pasta

A base di brodifacoum
Con semi di girasole

Radenticide pasta bait
Contains Brodifacoum
With sunflower seeds

97933

250 g



Esca roenticida in pasta

A base di bromadiolone

Radenticide pasta bait
Contains Bromadiolone

97934

500 g



Esca roenticida in grano

A base di bromadiolone

Radenticide grain bait
Contains Bromadiolone

97935

500 g



Esca lumachicida granulare

Resistente alla pioggia
A base di metaldeide

Granular snail bait
Rain resistant
Metaldehyde based

97947

500 gr





Disabituante per piccioni Repellent for pigeons
Spray per esterni Spray for outdoor use

97945 750 ml 8 000071 979450

Disabituante per cani e gatti Repellent for dogs and cats
Spray per esterni Spray for outdoor use

97946 750 ml 8 000071 979467



Insetticida liquido Liquid insecticide
Contro i parassiti delle piante Against plant pests
A base di piretro naturale Based on natural pyrethrum
Con erogatore spray With trigger sprayer
Pronto all'uso Ready to use

95706 500 ml 8 000071 957069



Lucidante fogliare spray Leaf shine spray
Mantiene le foglie sane pulite Maintains leaves healthy and clean
Protegge dalla cocciniglia Protects from cochineal

95704 400 ml 8 000071 957045



Stimolante per il compostaggio Compost accelerator
Accelera e ottimizza il processo di decomposition Speeds up decomposition process
Assorbe i cattivi odori Reduce unpleasant odors

99188 1 Kg 8 000071 991889





concimi fertilizers



Concimi liquidi

Da diluire 1 tappo in 2 litri d'acqua
Formato 1 Kg

Liquid fertilizers

Mix 1 cupful in 2 liter of water
Bottle 1 Kg

95694	universale	8 000071 956949
95695	per gerani e piante fiorite	8 000071 956956
95696	per piante verdi	8 000071 956963
96896	per piante acidofile (Azalee, Ortensie, Rododendri, Gardenia, Camelia, ecc)	8 000071 968966
95697	a base di sangue di bue	8 000071 956970



Concimi liquidi

Da diluire 1 tappo in 2 litri d'acqua
Formato 500 g

Liquid fertilizers

Mix 1 cupful in 2 liter of water
Bottle 500 g

95698	per agrumi	8 000071 956987
95699	per piante grasse	8 000071 956994



Concimi granulari

Formato 1 Kg

Granular fertilizers

Pack size 1 Kg

95700	per gerani e piante fiorite	8 000071 957007
95701	per rose e arbusti da fiore	8 000071 957014



Concimi granulari

Formato 2 Kg

Granular fertilizers

Pack size 2 Kg

95702	universale e per orto	8 000071 957021
95703	per prati e giardini	8 000071 957038



Per tappeti erbosi / For turf grass

96894 prato calpestabile 1 Kg (per 40 m²) 8 000071 968942

96895 Dichondra Repens 250 g (per 25 m²) 8 000071 968959



weed control **corroborante**



Aceto Acido acetico

In alta concentrazione
Soluzione naturale per le infestanti
Ideale per giardini, vialetti, orti
Pronto all'uso

Vinegar Acetic acid
High concentration
Natural solution for weed
Ideal for gardens and driveways
Ready to use

99187 1 litro 8 000071 991872



CONSENTITO IN
AGRICOLTURA BIOLOGICA



vaseline oil **olio di vaselina**



Enoil

Olio di vaselina F.U.
Paraffina liquida
Purissimo, inodore, insapore

Enoil
Food Grade Vaseline Oil
Liquid paraffin
Pure, odorless, tasteless

99220 1 Litro 8 000071 992206





olio per legno wood oil



Olio spray per legno
 Protezione e finitura del legno
 Specifico per mobili giardino in teak
 Trasparente

Oil spray for wood
 Maintenance and wood protection
 Specific for garden furniture in teak
 Transparent

93352

500 ml



8 000071 933520

accendifuoco firelighters



Ecologico - Solido in spicchi
 32 pezzi

Ecologic - Solid type
 32 pieces

99271



8 000071 992718



Per legna e carbone
 Solido in cubetti
 48 pezzi

For wood and charcoal
 Solid type
 48 pieces

87278



8 000071 872782

Espositore 1/4 di pallet
 270 conf. accendifuoco da
 48 cubetti (cod. 87278)

1/4 pallet display
 270 pack of 48 cubes firelighters
 (cod. 87278)

95415



8 000071 954150



Naturali
 Lana di legno e cera
 Sacchetto da 24 pezzi

Naturali
 Wood and wax
 Bag of 24 pieces

96482



8 000071 964821



Liquido in bottiglia - 1 litro

Liquid in bottle - 1 litre

87358



8 000071 873581



Ecologico
 Solido in cubetti
 Sacchetto da 72 pezzi

Ecological
 Solid type
 Bag of 72 pieces

94143



8 000071 941433

Espositore 1/4 di pallet
 64 conf. accendifuoco in sacco da
 72 cubetti ecologici (cod. 94143)

1/4 pallet display
 64 bags of 72 cubes of ecological
 firelighters (cod. 94143)

95414



8 000071 954143



Tronchetto antifuliggine

Pulisce il camino dalle incrostazioni di fuliggine

Sweeping log
Cleans soot deposit from fire-place and chimney

94427



Guanto per barbecue in pelle

Lunghezza 34 cm

Leather barbecue glove
Length 34 cm

• 91142



Carbone in sacchetti / Charcoal bag

81445 3 Kg

81446 4 Kg

52691 5 Kg



Ciminiera d'accensione
Per carbone

Chimney starter
For barbecue charcoal

97731



Pietra lavica per barbecue / Lava rock for bbq

61550 2 Kg





accessori barbecue barbecue accessories

**papillon**Pinza per barbecue
In acciaio con manici gommatiBarbecue tong
Stainless steel with soft grip handles**95425**

8 000071 954259

**papillon**Forchettone per barbecue
In acciaio con manici gommatiBarbecue fork
Stainless steel with soft grip handles**95426**

8 000071 954266

**papillon**Paletta per barbecue
In acciaio con manici gommatiSpatula
Stainless steel with soft grip handles**95427**

8 000071 954273

**papillon**Spazzola per barbecue
In acciaio con manici gommatiCleaning brush
Stainless steel with soft grip handles**95428**

8 000071 954280

**papillon****Set attrezzi barbecue - 3 pezzi**
Spatola, pinza, e forchettone
In acciaio con manici gommatiBarbecue tool set - 3 pieces
Spatula, tong and fork
Stainless steel with soft grip handles**94600**

8 000071 946001

**papillon****Set attrezzi barbecue - 6 pezzi**
Spatola, pinza e forchettone
In acciaio con manici in legno
Grembiule (ripiegato funge da custodia)
Guanto in tessuto
Set sale e pepe in metalloBarbecue tool set - 6 pieces
Spatula, tong and fork
Stainless steel with wood handles
Apron (folds into an easy-to-carry tote)
Oven glove
Salt and pepper pots**94601**

8 000071 946018



Griglia tondino

Acciaio inox
Con 2 manici e piedini

Cooking grills
Stainless steel
With 2 handles and feet

99097

35x35x11 cm



99098

47x35x11 cm



99099

60x40x11 cm



Griglia doppia

Acciaio inox
Con manico e piedini

Double cooking grills
Stainless steel
With handle and feet

99100

27x27x7 cm



99101

37x27x7 cm



99102

40x35x7 cm

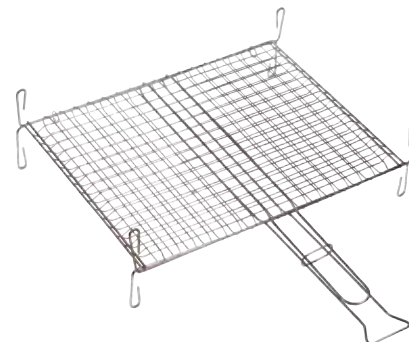

mod. COCINERO

Braciere acciaio verniciato
Reggibrace acciaio verniciato
Paravento acciaio verniciato antigraffio
Griglia cromata regolabile
Dimensioni: Ø 36 x 51H cm
Peso 2,8 Kg

Painted steel brazier
Painted steel grid
Painted steel windshield scratch resistant
Chrome-plated grill adjustable
Dimensions: Ø 36 x 51H cm
Weight 2,8 Kg

91264



mod. DAKOTA

Braciere acciaio verniciato
Reggibrace acciaio verniciato
Griglia cromata regolabile
Dimensioni: 53x33x56H cm
Peso 4 Kg

Painted steel brazier
Painted steel grid
Chrome-plated grill adjustable
Dimensions: 53x33x56H cm
Weight 4 Kg

95416





barbecues barbecues



mod. APACHE

Braciere acciaio verniciato
 Reggibrace acciaio verniciato
 Paravento acciaio verniciato antigraffio
 Griglia cromata regolabile
 Piano d'appoggio inferiore
 Con 2 ruote
 Dimensioni: Ø 53 x 82H cm
 Peso 6,7 Kg

Painted steel brazier
 Painted steel grid
 Painted steel windshield scratch resistant
 Chrome-plated grill adjustable
 Bottom shelf
 With 2 wheels
 Dimensions: Ø 53 x 82H cm
 Weight 6,7 Kg

93281



mod. ESKIMO

Coperchio in acciaio verniciato
 Braciere acciaio verniciato
 Reggibrace acciaio verniciato
 Griglia di cottura Ø 57 cm
 Portacenere rimovibile
 Termometro integrato nel coperchio
 Valvola di aerazione
 Piano d'appoggio inferiore
 Con 2 ruote
 Dimensioni: 61x58x89H cm
 Peso 10 Kg

Painted steel cover
 Painted steel brazier
 Painted steel grid
 Cooking grill Ø 57 cm
 Removable ash catcher
 Lid mounted thermometer
 Air vents
 Bottom shelf
 With 2 wheels
 Dimensions: 61x58x89H cm
 Weight 10 Kg

95419



mod. YAKAMA

Braciere acciaio verniciato
 Reggibrace acciaio verniciato
 Paravento acciaio antigraffio
 Griglia cromata regolabile
 Mensole laterali
 Piano d'appoggio inferiore
 Con 2 ruote
 Dimensioni: cm 53x32
 Peso 6 Kg

Painted steel brazier
 Painted steel grid
 Steel windshield scratch resistant
 Chrome-plated grill adjustable
 Side shelves
 Bottom shelf
 With 2wheels
 Dimensions: cm 53x32
 Weight 6 Kg

95417



**mod. WICHITA**

Braciere acciaio verniciato
 Reggibrace acciaio verniciato
 Doppia griglia di cottura regolabile in 3 posizioni
 Piano d'appoggio inferiore inferiore
 Telaio tubolare quadro con 2 ruote
 Dimensioni: 98x55x93H cm
 Peso 14 Kg

Painted steel brazier
 Painted steel grid
 Double cooking grill adjustable in 3 position
 Bottom shelf
 Tubular square frame, with 2 wheels
 Dimensions: 98x55x93H cm
 Weight 14 Kg

95418



barbecues a gas gas barbecues

**papillon****mod. CROW**

Griglia smaltata 45x30 cm
 Bruciatori in alluminio a gas a fiamma stabilizzata
 Potenza 5 kW
 Accensione piezoelettrica
 Coperchio in acciaio verniciato
 Piani laterali e inferiore in acciaio
 Con 2 ruote
 Dimensioni: 101X46X95H cm
 Incluso 1,5 Kg lava rock
 Peso 9 Kg

Enamelled grid 45x30 cm
 Stabilized flame gas burner
 Power 5 kW
 Piezoelectric lighter
 Steel cover
 Steel sides and inferior tables
 With 2 wheels
 Dimensions: 101x46x95H cm
 1,5 Kg lava rocks included
 Weight 9 Kg

99195

8 000071 991957

**papillon****mod. PONCA**

Griglia smaltata 45x30 cm
 Bruciatori in alluminio a gas a fiamma stabilizzata
 Potenza 5 kW
 Accensione piezoelettrica
 Coperchio in acciaio verniciato con termometro
 Fornello laterale aggiuntivo
 Piani laterali e inferiore in acciaio
 Telo anteriore in tessuto
 Con 2 ruote
 Dimensioni: 101X46X95H cm
 Incluso 1,5 Kg lava rock
 Peso 9 Kg

Enamelled grid 45x30 cm
 Stabilized flame gas burner
 Power 5 kW
 Piezoelectric lighter
 Steel cover with thermometer
 Additional side burner
 Steel sides and inferior tables
 Frontal canvas
 With 2 wheels
 Dimensions: 101x46x95H cm
 1,5 Kg lava rocks included
 Weight 9 Kg

99196

8 000071 991964



papillon

mod. WACO

3 fuochi + fornello laterale
 Potenza 7,5 kW
 Accensione piezoelettrica
 Bruciatore in acciaio inox
 Griglia smaltata 41,5x38 cm
 Piastra laterale 40x26 cm
 Coperchio in acciaio verniciato con termometro
 Telo frontale in tessuto
 Con 2 ruote
 Dimensione: 130x48x97 cm
 Incluso 1,5 Kg lava rock
 Peso 24 Kg

3 burners + side burner foldaway
 Power 7,5 kW
 Piezoelectric lighter
 Stainless steel gas burner
 Enamelled grid 41,5x38 cm
 Side plate 40x26 cm
 Steel cover with thermometer
 Frontal canvas
 With 2 wheels
 Dimensions: 130x48x97H cm
 1,5 Kg lava rocks included
 Weight 24 Kg

97720



**fornelli elettrici** electric cookers

CE

**Fornello a 1 piastra**

Ø piastra 185 mm
Potenza 1500 W
Max temperatura 500° C
Termostato regolabile

Single plate cooker
Ø hot plate 185 mm
Power 1500 W
Max temperature 500° C
Adjustable thermostat

• 99191



8 000071 991919



CE

**Fornello a 2 piastre**

Ø piastra 155 / 185 mm
Potenza 1000 + 1500 W
Max temperatura 500° C
Termostato regolabile

Double plate cooker
Ø hot plate 155 / 185 mm
Power 1000 + 1500 W
Max temperature 500° C
Adjustable thermostat

• 99192



8 000071 991926

fornelli a gas gas stoves**Fornello a 2 fuochi**

Brucciatori Ø 53 / 59 mm
Consumo nominale 190 g/h
Potenza 2,6 kW
Dimensioni 580x330x95 mm

Table gas 2 flames
Injectors Ø 53 / 59 mm
Nominal consumption 190 g/h
Power 2,6 kW
Dimensions 580x330x95 mm

• 95261



8 000071 952613

CE

**Fornello a 3 fuochi**

Brucciatori Ø 47 / 53 / 59 mm
Consumo nominale 252 g/h
Potenza 3,45 kW
Dimensioni 580x330x95 mm

Table gas 3 flames
Injectors Ø 47 / 53 / 59 mm
Nominal consumption 252 g/h
Power 3,45 kW
Dimensions 580x330x95 mm

• 95262



8 000071 952620

CE



mod. ESSENTIAL

Fornello a 3 fuochi

Bruciatori Ø 47 / 53 / 59 mm
Consumo nominale 393 g/h
Potenza 5,4 kW
Dimensioni 580x330x95 mm

Table gas 3 flames
Injectors Ø 47 / 53 / 59 mm
Nominal consumption 393 g/h
Power 5,4 kW
Dimensions 580x330x95 mm

• 99193



Fornellone in ghisa

A 3 piedi
Consumo nominale 400 g/h
Potenza 5,5 kW
Dimensioni 350x180 mm
Peso 5 Kg ca.

Cast iron gas burner
3 feet
Nominal consumption 400 g/h
Power 5,5 kW
Dimensions 350x180 mm
Weight 5 Kg ca.

• 83607



Fornellone in ghisa

A 4 piedi
Consumo nominale 400 g/h
Potenza 5,5 kW
Dimensioni 300x300 mm
Peso 5 Kg ca.

Cast iron gas burner
4 feet
Nominal consumption 400 g/h
Power 5,5 kW
Dimensions 300x300 mm
Weight 5 Kg ca.

• 92972



Dimensioni 400X400 mm
Peso 7 Kg ca.

Dimensions 400X400 mm
Weight 7 Kg ca.

• 83608



Fornellone in ghisa

A 3 rubinetti
Consumo nominale 625 g/h
Potenza 8,6 kW
Dimensioni 320x380x190 mm
Peso 8 Kg ca.

Cast iron gas burner
3 taps
Nominal consumption 625 g/h
Power 8,6 kW
Dimensions 320x380x190 mm
Weight 8 Kg ca.

• 99007





fornelli a gas gas stoves



Conforme alla nuova normativa

CE

**Fornello portatile**

Per cartucce 230 g
Struttura in lamiera smaltata
Innesto rapido cartuccia
Accensione automatica
Chiusura di sicurezza
Consumo nominale 155 g/h
Potenza 2500 W

Portable gas cooker
For 230 g cartridges
Enameled pan holder
Quick-release gas cartridge
Automatic ignition
Safety locking mechanism
Nominal consumption 155 g/h
Power 2500 W

• 99190



8 000071 991902



CE



Per cartucce gas butano da 190 g
Consumo nominale 78 g/h
Potenza nominale 1.1 kW
Accensione manuale

For butane 190 g cartridge
Nominal consumption 78 g/h
Power 1.1kW
Manual ignition

• 93307



8 000071 933070

Accensione piezoelettrica

Piezo electric ignition

• 93308



8 000071 933087



CE



Fornello cromato per bombole
Consumo nominale 78 g/h
Potenza 1100 W
Ø piastra 220 mm
Accensione manuale

Gas stove
Nominal consumption 78 g/h
Power 1100 W
Ø hot plate 220 mm
Manual ignition

• 94332



8 000071 943321



Cartuccia a forare universale
Gas butano - 190 g

Universal piercing cartridge
Butane gas - 190 g

98423



8 000071 984232



Cartuccia gas butano - 227 g / Butane gas cartridge - 227 g

• 93900



8 000071 939003



Per cartucce gas butano da 190 g
Consumo nominale 70 g/h
Potenza 1 kW
Accensione manuale

For butane 190 g cartridge
Nominal consumption 70 g/h
Power 1 kW
Manual ignition

• 93305



Accensione piezoelettrica

Piezo electric ignition

• 93306



Vetro cilindrico di ricambio / Cylindrical glasses

• 61336



Reticelle per lampada a gas (3pz) / Mantles for gas lamp (3 pcs)

• 61335





borse termiche cooler bags



220 volt

12 volt



Caldo e Freddo

Classe A+



Frigo box passivo

Dim. 380 x 260 x 390 mm (25 Litri)
Dim. 380 x 260 x 465 mm (30 Litri)

Cool box

Dim. 380 x 260 x 390 mm (25 Litri)
Dim. 380 x 260 x 465 mm (30 Litri)

99213

25 Litri



99214

30 Litri



Frigo box elettrico

Funzione caldo e freddo

Con spinotto 12 V e spina 230 V

Classe di efficienza energetica A+

Dim. 380 x 260 x 430 mm

Electric cool box

Hot and cold function

With 12 V and 230 V sockets

Energy efficiency class A+

Dim. 380 x 260 x 430 mm

99215

25 Litri



esterno 100% poliestere
fodera 100% PEVA
interno 100% schiuma



esterno 100% poliestere
fodera 100% PEVA
interno 100% schiuma



Trolley

Dimensioni / Dimensions : 38 x 29 x 37 cm

• 95092

38 Litri



Zaino con marsupio rimovibile

Dimensioni : 33 x 15 x 49 cm

• 95091

28 Litri



Backpack with detachable pouch bag

Dimensions : 33 x 15 x 49 cm



esterno 100% poliestere
fodera 100% PEVA
interno 100% schiuma



Portabottiglia - Dimensioni / Dimensions : Ø 10 x 18 cm

• 94595

2 Litri



esterno 100% poliestere
fodera 100% PEVA
interno 100% schiuma



Dimensioni / Dimensions : 25 x 16 x 18 cm

• 94591

5 Litri



esterno 100% poliestere
fodera 100% PEVA
interno 100% schiuma



Dimensioni / Dimensions : 29 x 22 x 35 cm

• 95089

20 Litri



esterno 100% poliestere
fodera 100% PEVA
interno 100% schiuma



Dimensioni / Dimensions : 30 x 28 x 35 cm

• 95090

28 Litri



Accumulatori di freddo / Ice pack (Conf. 2 pezzi)

95176

200 gr

Dim. 40 x 74 x 165 mm

95178

500 gr

Dim. 80 x 95 x 180 mm



esterno 100% poliestere
fodera 100% Silver film
interno 100% schiuma



Dimensioni / Dimensions : 34 x 17 x 34 cm

• 94594

18 Litri



DISTRIBUZIONE



www.ferritalia.it



Punte per trapani
Drills
Austria



Utensili elettrici - a batteria
Utensili aria compressa - Saldatrici
Electric and cordless tools
Air tools - Welding



Utensili manuali professionali
per meccanica ed edilizia
Mechanic and building
professional hand tools



Utensileria manuale - Carrelli
Strumenti di misura - Casseforti
Siliconi - Illuminazione
Hand tools - Hand trucks - Sealants
Measuring instruments - Lighting



Tubo No-torsion
No-Torsion hose
Italia



Macchine ed attrezzi per giardino
Equipment and garden tools

N.B. I dati e le caratteristiche tecniche dei prodotti riportati sul presente catalogo si intendono puramente indicativi.

Le potenze indicate per i vari motori sono da considerarsi nominali.

Ferritalia si riserva di apportare in qualsiasi momento variazioni alle caratteristiche tecniche e misure di tutti i modelli illustrati.

Ferritalia reserves the right to make changes in his products without notice.

Finito di stampare gennaio 2017



FERRITALIA società cooperativa
via Longhin, 71 - 35129 PADOVA
tel. +39 049 8076244 - 049 8076018
fax +39 049 8071259
www.ferritalia.it | info@ferritalia.it
www.papillon.ferritalia.it